

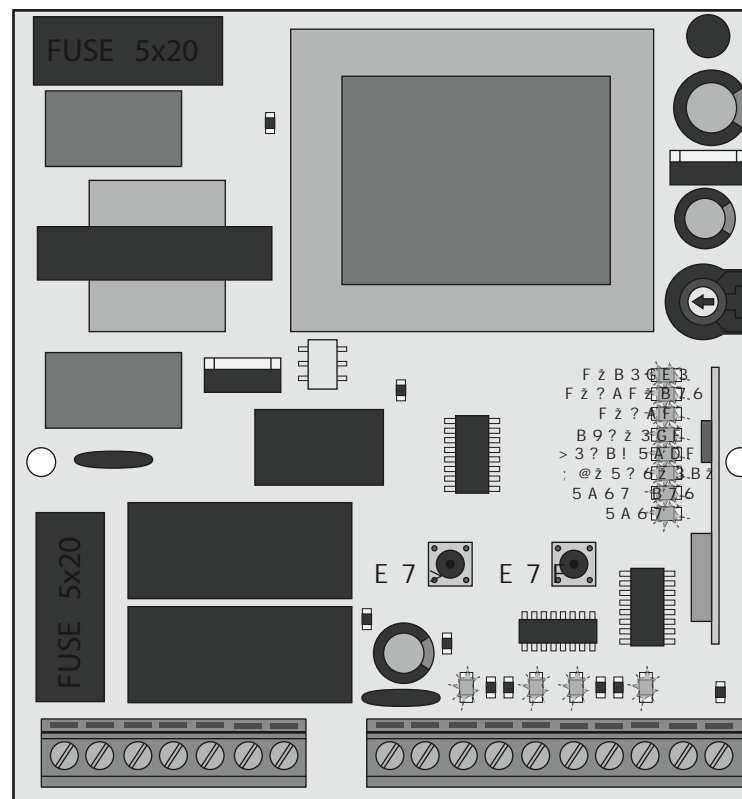

MC1

USER / INSTALLER MANUAL







00. CONTENT

INDEX

01. SAFETY INSTRUCTIONS	1B
02. THE CONTROL BOARD	
CONNECTIONS SCHEME	4
TECHNICAL CHARACTERISTICS	5A
CONNECTORS DESCRIPTION	5A
PROGRAMMING PRE-RECOMENDATIONS	5B
SEL/SET BUTTONS	6A
MOTOR'S STRENGTH AND SPEED	6A
FUSES	6A
LEDS	6B
03. INSTALLATION	
CONDITIONS AND PRE VERIFICATIONS	7A
ESSENTIAL INSTALLATION STEPS	7A
CONTROL BOARD INSTALLATION	7B
04. PROGRAMMING	
PRE-INSTALLATION WARNINGS	8A
MAIN MENU	9A
EXTENDED MENU 1	12B
EXTENDED MENU 2	14B
OTHER INFORMATION	15
05. MAINTENANCE	
PARAMETERS TO TAKE CARE	15B
06. TROUBLESHOOTING	
COMPONENTS TEST	16A
PHOTOCELLS AND TRANSMITTER TESTS	16B
INSTRUCTIONS FOR FINAL CONSUMERS	17
INSTRUCTIONS FOR SPECIALIZED INSTALLERS	17

01. SAFETY INSTRUCTIONS

ATTENTION:

	This product is certified in accordance with European Community (EC) safety standards.
	This product complies with Directive 2011/65/EU of the European Parliament and of the Council, of 8 June 2011, on the restriction of the use of certain hazardous substances in electrical and electronic equipment and with Delegated Directive (EU) 2015/863 from Commission.
	(Applicable in countries with recycling systems). This marking on the product or literature indicates that the product and electronic accessories (eg. Charger, USB cable, electronic material, controls, etc.) should not be disposed of as other household waste at the end of its useful life. To avoid possible harm to the environment or human health resulting from the uncontrolled disposal of waste, separate these items from other types of waste and recycle them responsibly to promote the sustainable reuse of material resources. Home users should contact the dealer where they purchased this product or the National Environment Agency for details on where and how they can take these items for environmentally safe recycling. Business users should contact their vendor and check the terms and conditions of the purchase agreement. This product and its electronic accessories should not be mixed with other commercial waste.
	
	This marking indicates that the product and electronic accessories (eg. charger, USB cable, electronic material, controls, etc.) are susceptible to electric shock by direct or indirect contact with electricity. Be cautious when handling the product and observe all safety procedures in this manual.

01. SAFETY INSTRUCTIONS

GENERAL WARNINGS

- This manual contains very important safety and usage information. Read all instructions carefully before beginning the installation/usage procedures and keep this manual in a safe place that it can be consulted whenever necessary.
- This product is intended for use only as described in this manual. Any other enforcement or operation that is not mentioned is expressly prohibited, as it may damage the product and put people at risk causing serious injuries.
- This manual is intended firstly for specialized technicians, and does not invalidate the user's responsibility to read the "User Norms" section in order to ensure the correct functioning of the product.
- The installation and repair of this product may be done by qualified and specialized technicians, to assure every procedure are carried out in accordance with applicable rules and norms. Nonprofessional and inexperienced users are expressly prohibited of taking any action, unless explicitly requested by specialized technicians to do so.
- Installations must be frequently inspected for unbalance and the wear signals of the cables, springs, hinges, wheels, supports and other mechanical assembly parts.
- Do not use the product if it is necessary repair or adjustment is required.
- When performing maintenance, cleaning and replacement of parts, the product must be disconnected from power supply. Also including any operation that requires opening the product cover.
- The use, cleaning and maintenance of this product may be carried out by any persons aged eight years old and over and persons whose physical, sensorial or mental capacities are lower, or by persons without any knowledge of the product, provided that these are supervision and instructions given by persons with experienced in terms of usage of the product in a safe manner and who understands the risks and dangers involved.

- Children shouldn't play with the product or opening devices to avoid the motorized door or gate from being triggered involuntarily.

WARNINGS FOR TECHNICIANS

- Before beginning the installation procedures, make sure that you have all the devices and materials necessary to complete the installation of the product.
- You should note your Protection Index (IP) and operating temperature to ensure that is suitable for the installation site.
- Provide the manual of the product to the user and let them know how to handle it in an emergency.
- If the automatism is installed on a gate with a pedestrian door, a door locking mechanism must be installed while the gate is in motion.
- Do not install the product "upside down" or supported by elements do not support its weight. If necessary, add brackets at strategic points to ensure the safety of the automatism.
- Do not install the product in explosive site.
- Safety devices must protect the possible crushing, cutting, transport and danger areas of the motorized door or gate.
- Verify that the elements to be automated (gates, door, windows, blinds, etc.) are in perfect function, aligned and level. Also verify if the necessary mechanical stops are in the appropriate places.
- The central must be installed on a safe place of any fluid (rain, moisture, etc.), dust and pests.
- You must route the various electrical cables through protective tubes, to protect them against mechanical exertions, essentially on the power supply cable. Please note that all the cables must enter the central from the bottom.
- If the automatism is to be installed at a height of more than 2,5m from the ground or other level of access, the minimum safety and health requirements for the use of work equipment workers at the work of

01. SAFETY INSTRUCTIONS

Directive 2009/104/CE of European Parliament and of the Council of 16 September 2009.

- Attach the permanent label for the manual release as close as possible to the release mechanism.
- Disconnect means, such as a switch or circuit breaker on the electrical panel, must be provided on the product's fixed power supply leads in accordance with the installation rules.
- If the product to be installed requires power supply of 230Vac or 110Vac, ensure that connection is to an electrical panel with ground connection.
- The product is only powered by low voltage safety with central (only at 24V motors)

WARNINGS FOR USERS

- Keep this manual in a safe place to be consulted whenever necessary.
- If the product has contact with fluids without being prepared, it must immediately disconnect from the power supply to avoid short circuits, and consult a specialized technician.
- Ensure that technician has provided you the product manual and informed you how to handle the product in an emergency.
- If the system requires any repair or modification, unlock the automatism, turn off the power and do not use it until all safety conditions have been met.
- In the event of tripping of circuits breakers or fuse failure, locate the malfunction and solve it before resetting the circuit breaker or replacing the fuse. If the malfunction is not repairable by consult this manual, contact a technician.
- Keep the operation area of the motorized gate free while the gate in in motion, and do not create strength to the gate movement.
- Do not perform any operation on mechanical elements or hinges if the product is in motion.

RESPONSABILITY

- Supplier disclaims any liability if:
 - Product failure or deformation result from improper installation use or maintenance!
 - Safety norms are not followed in the installation, use and maintenance of the product.
 - Instructions in this manual are not followed.
 - Damaged is caused by unauthorized modifications
 - In these cases, the warranty is voided.

MOTORLINE ELECTROCELOS SA.

Travessa do Sobreiro, nº29
4755-474 Rio Côvo (Santa Eugénia)
Barcelos, Portugal

SYMBOLS LEGEND:



• Important safety notices



• Useful information



• Programming information



• Potentiometer information



• Connectors information



• Buttons information

02. THE CONTROL BOARD

CONNECTION SCHEME

The MC1 is an electronic single phase control board with control system via built-in radio, developed for the automations control for sliding gates or just 1 motor for swing gate.

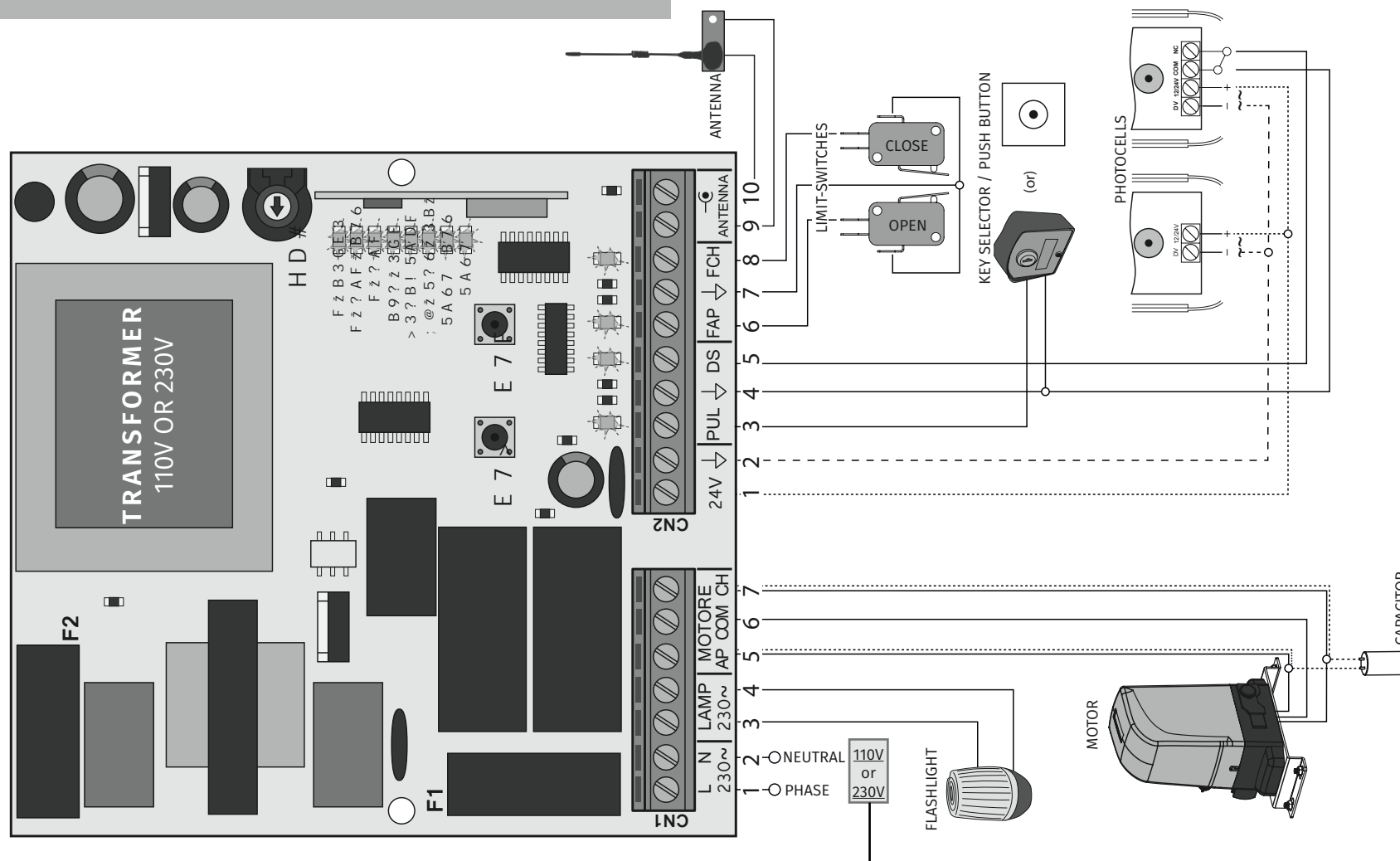

02. THE CONTROL BOARD

TECHNICAL CHARACTERISTICS

• Power Supply	110V or 230V AC 50-60Hz 900W max. (4A)
• Lightbulb or courtesy light output	110V/230V AC 500W max. 100W (max. resistive cargo) 50W (max. induced cargo)
• Motor's output	110V/230V AC 50/60Hz 750W max.
• Output for powering accessories	24V AC 3W max.
• Working temperature	-20°C to +55°C
• Incorporated Radio Receiver	433,92 Mhz
• Code types	12-18 bits or Rolling Code
• Maximum memory capacity	120 codes (CODE or CODE PED)
• Control board dimensions	108x138 mm

• CONNECTOR'S DESCRIPTION

CN1	<ul style="list-style-type: none"> 01 • 110V/230V Line Input (PHASE) 02 • 110V/230V Line Input (NEUTRAL) 03 • Lightbulb / Courtesy light's output (GND/COM) 04 • Lightbulb / Courtesy light's output (phase) 05 • Motor's Output (opening) 06 • Motor's Output (GND/COM) 07 • Motor's Output (closing)
	<p>ATTENTION 03 to 07 output: The output voltage depends on the supply voltage (01 and 02)</p>
CN2	<ul style="list-style-type: none"> 01 • Output for powering photocells (24V AC - 6W Max.) 02 • Output for powering photocells (GND/COM) 03 • Step-by-step pushbutton input (NO) 04 • GND/COM output 05 • Security devices input (NC) 06 • Opening limit-switch input (NC) 07 • GND/COM output 08 • Closing limit-switch input (NC) 09 • Antenna input (mass) 10 • Antenna input (hot pole)

02. THE CONTROL BOARD

TECHNICAL CHARACTERISTICS

• PROGRAMMING PRE-RECOMENDATIONS

Before proceeding to the control board configuration, note the following points listed in the table below to better understand the control board's functions:

CN1	<p>Flashing / Courtesy light: 03 and 04 • This output allows connection of a 110V / 230V courtesy light or a flashing light (see page 3). This output does not flash.</p>
CN2	<p>Step by step pushbutton: 03 and 04 • This input (NO) allows to control the control board through pushbuttons. When you receive the first order, it triggers the opening until the motor's working time ends or until it detects the opening limit switch. When it receives a second order, it triggers the closing. If you receive an order during the opening or closing of the gate, the movement stops and it's only restored (in the opposite direction from what it was before it stops) after receiving a new order. During opening, if it receives an order to stop (active T.PAUSA), it will temporize and close the gate.</p>
CN2	<p>TIMER functioning: 03 and 04 • The control board allows a connection of a TIMER. With this device, you can set an exact time for the gate to perform the opening / closing automatically. For example: If you program a time between 8 am and 10 am, this will cause an opening contact at 8 am and will maintain the contact until 10am. At 10am, the gate will perform the closing, after waiting the pause time. (It is important to enable automatic closure)</p>
CN2	<p>Safety circuits: 05 • This circuit allows photocells connection. This device operates only in the gate closure, and when triggered, reverses the direction gate movement.</p>
CN2	<p>Limit-switches: 06 to 08 • The control board needs the connection limit switches in opening and closing (both NC). The trigger of any one of the limit switches causes the immediate stop of the gate's movement. The limit switches triggering is signaled by the LEDs FCH and FAP. When a limit switch is activated, the respective LED goes off. The LED FAP corresponds to opening limit switch and the LED FCH to the closing limit switch. If you do not use limit switches (swing gate) should close with a shunt circuits 6-7 and/or 7-8 of the CN2 connector. It is mandatory the use of limit switches on sliding gate motors!</p>

02. THE CONTROL BOARD

TECHNICAL SPECIFICATIONS

• SEL/SET BUTTONS



SEL

SEL key:

To select the function to change. This selection is identified by the intermittency of LED corresponding to the selected function at that time. Pressing the SEL key repeatedly will cycle through the various functions to be programmed. The selection remains active for 10 seconds, and after that time the control board returns to the original state (no active selection).



SET

SET key:

To program the selected function with the SEL key.

 The SET key can be replaced by transmitter key, as long it finds itself programmed.

• MOTOR'S FORCE AND SPEED



VR1

VR1 potentiometer:

The control board has a "VR1" potentiometer to adjust the force and speed of the motors, controlled by the microprocessor. Adjustment can be made between 50% and 100% force / speed. In each starting movement, the control board applies the maximum force for 2 seconds, even when a force adjustment is made to a value other than the maximum.



When you adjust the VR1 potentiometer, it is necessary to redo the programming course, because the maneuver and slowdown times may vary.

• FUSES

There are two fuses that protect the center against electrical overloads. These protection devices are an essential part of the power distribution system as they prevent damage to other circuit elements.

F1 T6.3AL250V - 3A 250V

F2 50mAL250V - 50mA 250V

02. THE CONTROL BOARD

TECHNICAL SPECIFICATIONS

• LEDs

There are LEDs in the control board to inform the installer about connection status of the various components. Before the central configuration, note the behavior of these LEDs, which must match those described in the table below.

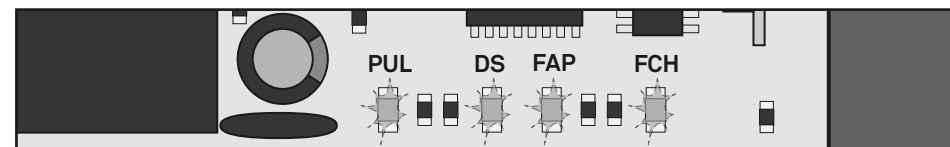

PUL

This LED signals the connection of accessories which control automatism functioning like key selectors or push buttons. It lights up when it receives accessories signals (contact changes from NO to NC). If you need to connect several components in this entry, they must be connected in parallel mode (direct connection on connector).

DS

The LED signals the connection of safety devices such as photocells or safety edge (required to MR12 connection). This LED is lit when a device is connected at the DS input (NC). Whenever the contact safety device is interrupted (NO | eg object between photocells), the LED turns off. If you need to connect multiple components on this input, they must be connected in series mode.

FAP

LED signals the connection of the opening limit switch. This LED stays lit as soon as the opening limit switch is connected into the terminal 6 of CN2 (NC). Whenever the opening limit switch is activated (NO), the LED will turn off.

FCH

LED signals the connection of the closing limit switch. This LED stays lit as soon as the closing limit switch is connected into the terminal 6 of CN2 (NC). Whenever the closing limit switch is activated (NO), the LED will turn off.

03. INSTALLATION

INSTALLATION ESSENTIAL GUIDE

• CONDITIONS AND PRE VERIFICATIONS

- Make sure that the motor is properly installed at the gate.
- Check if the ambient temperature values are acceptable for the functioning of this control board.
- Perform the entire installation with the power off.
- Consult the manufacturer's instructions from all the components to install.
- Always make a ground connection directly to the motor's metal structure.

• ESSENTIAL INSTALLATION STEPS

- Place the control board in the appropriate fixing location and tighten the screws to secure it.
- Make the connections of all the accessories and components you want to use, according to the wiring diagram (p. 4).
 - Connect the control board to a 110V or 230V power supply according to the value shown on the transformer (terminals 1 and 2 - CN1).
 - Check that the limit switches are working properly. (P. 8A)
 - Also check other devices like selectors or photocells. (P. 8B)
 - Start by programming a transmitter (p. 9A).
 - Now do an course's automatic programming (p. 10B).
 - If necessary, you can now adjust the strength / speed of the automatism in the VR1 potentiometer (p. 6A). Whenever any change is made in this potentiometer, you must redo the course's automatic programming.
 - Put silicone or another type of sealing in the cable entries of the control board box in order to prevent the entrance of insects or other elements that may damage the control board.



At this time, the control board is programmed with all the essential functions for a proper functioning of the automation. If you want to enable other control board functions, please check how to do so, on the following pages.

03. INSTALLATION

CONTROL BOARD INSTALLATION

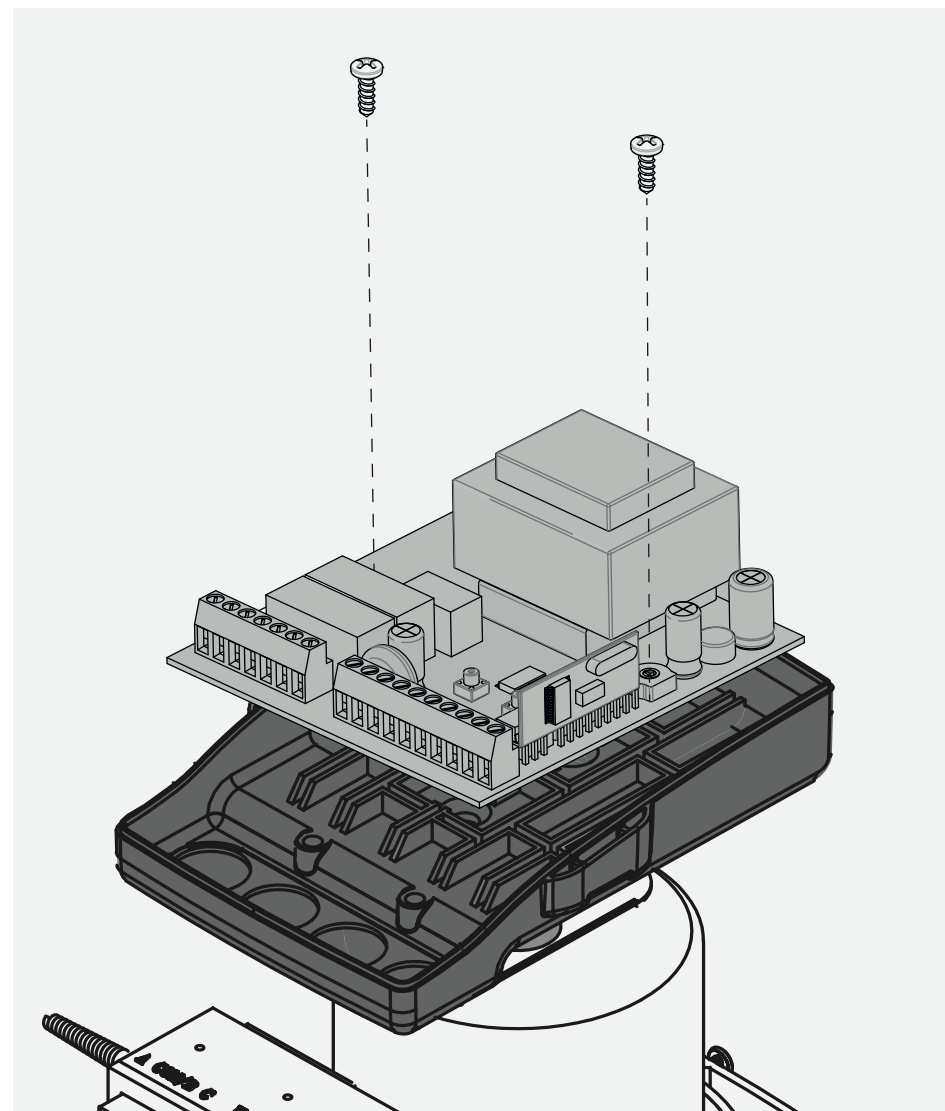

04. PROGRAMMING

PRE-INSTALLATION WARNINGS

After installing the control board and connecting the wires, you must ensure that all connected components are working properly. To do this, follow these steps:

• LIMIT SWITCHES TEST

First, you must define whether the operator is installed on the right or left of the gate. This information will indicate which side is the opening and closing.

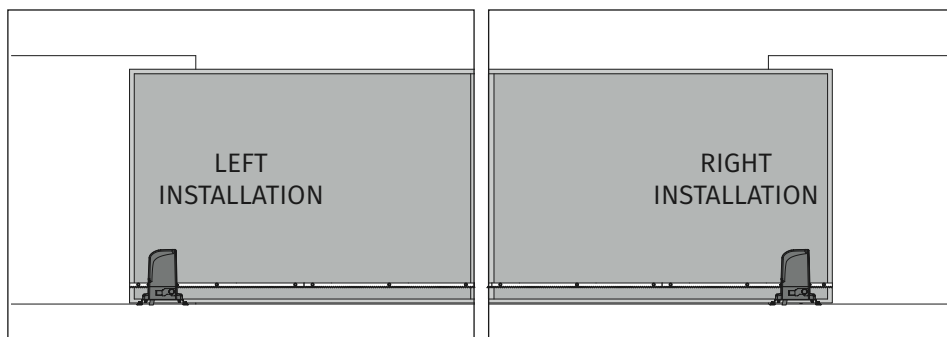

This test will be exemplified with the automation installed on the right.

Lean the automatism limit switch spring to the right until you hear a "click". The FAP LED must turn off! Now Lean the automatism limit switch spring to the left until you hear a "click". The FCH LED must turn off!

If the LEDs turn off oppositely, reverse the wires to the terminals 6 and 8 of CN2.

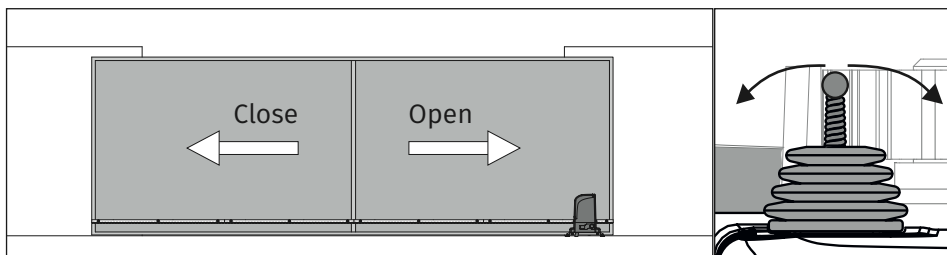

The limit switches are an important safety system of the motor. It is extremely important that they are properly connected in the control board, otherwise it may cause serious damage or injury.

04. PROGRAMMING

PRE-INSTALLATION WARNINGS

• PHOTOCELLS TEST

The photocells are a safety device that inform the control board that an object is obstructing the gate's route. They send a signal to prevent the gate from damaging the object.

The photocells are connected to the control board DS input (see wire connection page). This input has an assigned LED that informs about the connection status of the photocells. This LED is always lit when any safety device is connected (NC).

To test the connection of photocells in the control board, just interrupt the signal between the two photocells putting his hand in front of one of them. A sound similar to a "click" indicates that the signal was interrupted and the LED DS should be off while the photocells are interrupted. If it does not operate on this way, there is a problem in the connection between the photocells and the control board.

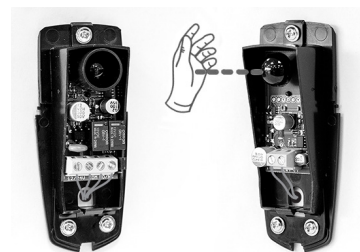

• KEY SELECTOR TEST

Components as key selector or push buttons are used to control the functioning of the gate. These components are connected to the control board PUL input (see wiring diagram on page 4). This input has an LED assigned that informs the connection status of the connected components. This LED remains off when a component is connected (NO mode).

To test the key selector connection in the control board, simply turn the key to one of the directions. At this time, the PUL LED lights up (NC), and turns off when the key goes back to the original position (NO). If it does not operate on this way, there is a problem in the connection between the device and the control board.



04. PROGRAMMING

MAIN MENU

The control unit is supplied by the manufacturer with the ability to select some main functions directly.

MAIN MENU		
LED	LED OFF	LED ON
• CODE	No programmed code	Programmed (s) code (s)
• CODE PED.	No programmed code	Programmed (s) code (s)
• IN.CMD.AP	CMD Opening Inhibition OFF	CMD Opening Inhibition ON
• LAMP/CORT	Flashing light mode	Courtesy Light Mode
• PGM. AUT.	Automatic Programming OFF	Automatic Programming ON
• T. MOT.	Working Time = 30 sec	Prog. time automatically
• T. MOT. PED	Pedestrian Working Time = 10 sec	Prog. time automatically
• T. PAUSA	Automatic Closing OFF	Automatic Closing ON

• **CODE** | PROGRAMMING TRANSMITTERS

This function allows you to program new transmitters to control the automatism. The control board only accepts Dip-Switch code transmitters or Rolling Code MOTORLINE, and has a maximum capacity of 120 codes. When trying to program the 121st code, all the programming LEDs blink a few times simultaneously signaling that the memory is full.

Programming new transmitters:

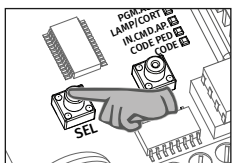

01 • Press the **SEL** key once, and the **CODE LED** begins to flash.

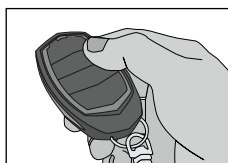

02 • Press once the transmitter's key you want to program, for 1 sec.

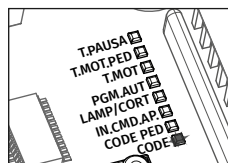

03 • The **CODE LED** remains permanently lit, signaling the program's success.

04. PROGRAMMING

MAIN MENU

Delete all configured transmitters:

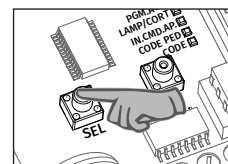

01 • Press the **SEL** key once, and the **CODE LED** begins to flash.

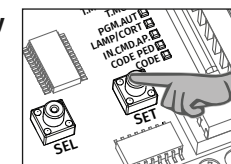

02 • Press the **SEL** key for **10 seconds!** The **CODE LED** turns off and all transmitters have been deleted.

i You can not delete only one specific transmitter!

• **CODE PED** | PEDESTRIAN FUNCTIONING

The control board allows you to program the gate to open just enough for the passage of people without making a full opening. The CODE PED function allows to program a code to command only this type of opening.

It is advised to do the programming of **T.MOT.PED** function to set the distance that the door should open, otherwise the control board will open a pre-set distance. The control board is supplied by the manufacturer with this function disabled.

Programming transmitters for pedestrian mode:

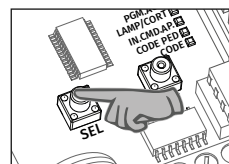

01 • Press **SEL** key twice, and the **CODE PED LED** begins to flash.

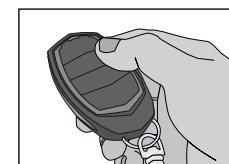

02 • Press once the transmitter's key you want to program, for 1 sec.

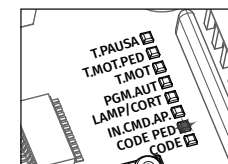

03 • The **CODE PED LED** remains permanently lit, signaling the program's success.

Delete all configured transmitters for pedestrian opening:

01. Press the SEL key twice until the LED CODE PED begins to flash.
02. Press the SET key for 10 seconds and all the codes from this function are deleted.

i It is not possible to erase just one transmitter. **Attention:** The "pedestrian passage" option occupies 1 slot of 120 available in the control board's memory. In other words, if you program, in the same transmitter, the CODE and CODE PED, you can still program 118 transmitters.

04. PROGRAMMING

MAIN MENU

• INB. CMD. AP | TRANSMITTER INHIBITION DURING THE OPENING AND PAUSE TIME

With the function activated, the control board rejects all the transmitters and devices signals during the opening maneuvers and automatic pause time. The control board is supplied by the manufacturer with this function deactivated.

Activate (LED ON) / deactivate (LED OFF) function:

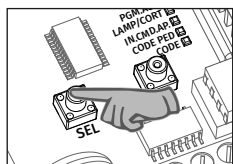

01 • Press the **SEL** button the times necessary until the **INB CMD AP LED** starts to flash.

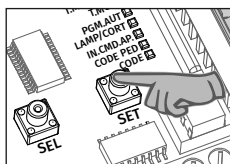

02 • Press **SET** button to enable / disable the function.

• LAMP/CORT | FLASHING LIGHT / COURTESY LIGHT SELECTION

The control board has a 110V / 230V AC output for connection of a flashing light or courtesy light at terminals 3 and 4 of CN1. This output does not flash. Observe the three possible behaviors:

OPTIONS	BEHAVIOR			
1 (factory)	Opening 	Pause Time 	Closing 	3min. After Closing
2	Opening 	Pause Time 	Closing 	3min. After Closing
3	Opening 	Pause Time 	Closing 	3min. After Closing

Enable OPTION 1:

With the LED lit, press SEL 4 or 5 times, and when the LED flashes (normally or quickly) press the SET button and the LED turns off.

Enable OPTION 2:

With the LED LAMP / CORT off, press 4 times the SEL key until this LED blinks normally. Press the SET button and the LED lights permanently.

Enable OPTION 3:

With the LED LAMP / CORT off, press 5 times the SEL key until this LED flashes quickly! Press the SET button and the LED lights permanently.

04. PROGRAMMING

MAIN MENU

• PGM. AUT. | COURSE AUTOMATIC PROGRAMMING

With the limit switches already set, the control board allows automatic programming of the working time (recommended).

Enable automatic programming:

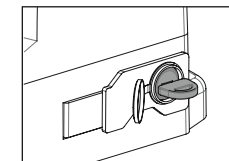
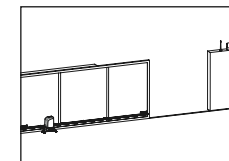
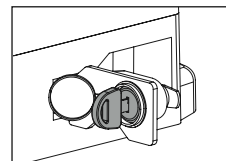

01 • Unlock the motor, put the gate halfway and lock the motor.

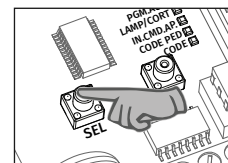

02 • Press the **SEL** button the times necessary until the **PGM AUT LED** starts to flash.

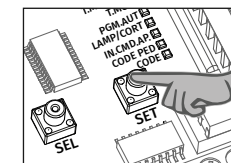

03 • Press and hold SET and the **door must begin to close!**



If the gate start to open, release the SET button, reverse the wires of links 5 and 7 of CN1, and start this program from the beginning.

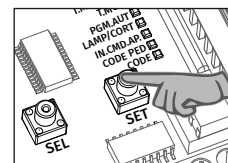

04 • Allow the gate to close, open and close again without releasing the **SET** button!

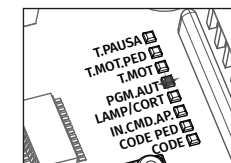

05 • When closing the 2nd time, the **PGM AUTO LED** will be lit and the programming has been successfully completed.

Automatic slowdown:

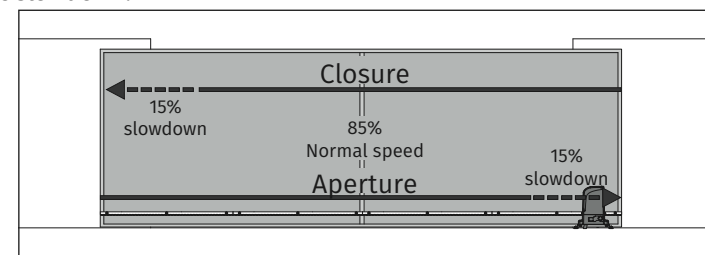

The control board automatically sets a slowdown in opening and closing equal to 15% of the total course.

04. PROGRAMMING

MAIN MENU

• T.MOT AND SLOWDOWN | PROGRAMMING MOTOR TIME AND RELAXATION (MANUALLY)

Unlike PGM.AUT, this function allows the programming of motor's time and slowdown manually. Use it whenever PGM.AUT does not meet your needs. If you set the course using this function after doing an automatic programming, the control board will forget the automatic programming and assumes the programmed course manually.

 Instead of using the central's SET button during programming, you can use the key of a remote control that is already programmed.

Programming motor's working time and slowdown (closed gate):

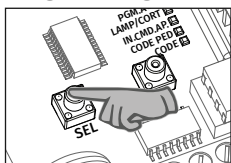

01 • Press **SEL** button the times necessary until the **T.MOT. LED** starts to flash.

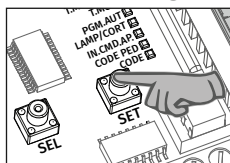

02 • Press **SET** button for 1 second, so that the motor starts the opening. 

 If the motor starts to close, invert the terminal cables 5 and 7 of the CN1 connector.

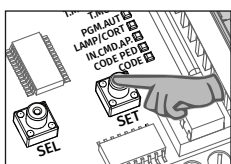

03 • Press **SET** button for 1 second, so that the motor starts the slowdown.

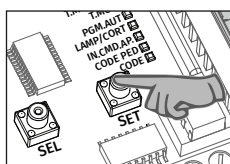

04 • Press again **SET** when you reach the opening limit switch.

The LED. T. MOT. will flash quickly indicating that the control board started programming the closing maneuver and the automation starts to close.

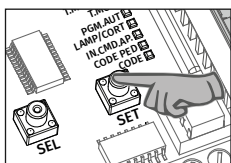

05 • Press **SET** button for 1 second, so that the motor starts the slowdown during closing.

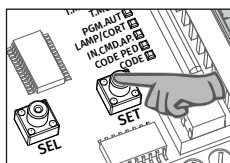

06 • Press again **SET** when you reach the closing limit switch.

Programming motor's working time without slowdown (closed gate):

To make the programming without slowdown, leave the gate reach the opening limit switch and press TWICE (quickly) the SET button.

The LED T. MOT. will flash quickly and the motor starts the closing maneuver.

When the gate reaches the closing limit switch again, click SET twice to finish programming.

04. PROGRAMMING

MAIN MENU

• T. MOT. PED | PROGRAMMING PEDESTRIAN WORKING TIME

This function allows you to manually program the distance that the gate opens to pedestrian crossing. The control board is supplied by the manufacturer with a pedestrian working time set at 10 seconds without slowdown.

 Instead of using the control board's SET button during programming, you can use the CODE key of an already programmed transmitter.

Programming pedestrian working time with slowdown (closed gate):

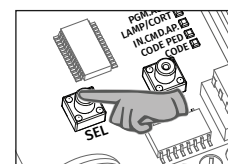

01 • Press **SEL** button the times necessary until the **T.MOT. LED** starts to flash.

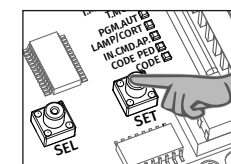

02 • Press **SET** button for 1 second, so that the motor starts the opening. 

 If the motor starts to close, invert the terminal cables 5 and 7 of the CN1 connector.

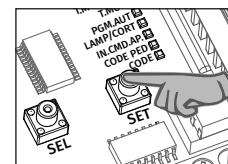

03 • Press **SET** button for 1 second, so that the motor starts the slowdown.

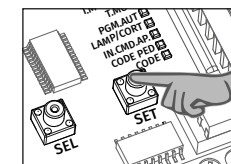

04 • Press again **SET** when you want to set the end of the pedestrian opening.

The LED T.MOT.PED. will flash quickly indicating that the control board started programming the pedestrian closing maneuver and the automation starts to close.

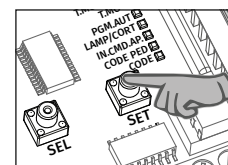

05 • Press **SET** button for 1 second, so that the motor starts the slowdown during closing.

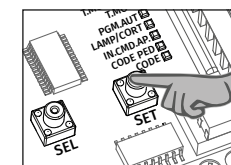

06 • Press again **SET** when you reach the closing limit switch.

Programming pedestrian motor's working time without slowdown (closed gate):

To make a program without slowdown, press TWICE the SET button when you want to set the opening's end.

T. MOT.PED LED will flash quickly and the motor starts the closing maneuver.

When the gate reaches the closing limit switch, click SET twice again to finish programming.

04. PROGRAMMING

MAIN MENU

• T. PAUSA | PROGRAMMING PAUSE TIME FOR AUTOMATIC CLOSING (MAX 4 MIN)

This function allows you to set the time that the gate remains open after the end of the opening maneuver. After this time, the control board automatically initiates the closing. The control board is supplied by the manufacturer without automatic closure.

Activate or change the pause time for automatic closure:

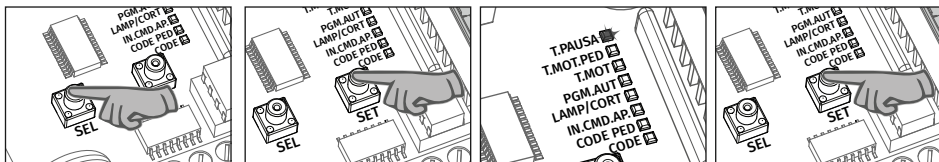

- 01** • Press **SEL** button the times necessary until the **T.PAUSA LED** starts to flash.
- 02** • Press **SET** button. The **T.PAUSA LED** starts to flash quickly.
- 03** • Wait the desired time for pause time. (Eg 30 seconds)
- 04** • Press **SET** button. **T. PAUSA LED** stays lit and the pause time is set.

Disable the automatic closing:

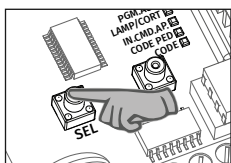

- 01** • Press **SEL** button the times necessary until the **T.PAUSA LED** starts to flash.

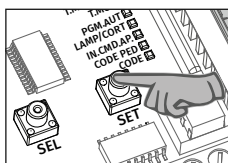

- 02** • Double-press the **SET** button within 2 sec! The **T.PAUSA LED** turns off and the function stays disabled.

04. PROGRAMMING

EXTENDED MENU 1

The control board is supplied with extra functions that can be activated through the extended menu 1.

EXTENDED MENU 1		
LED	LED OFF	LED ON
• CODE	Step by Step Mode	Automatic mode
• CODE PED.	Electric brake = OFF	Electric brake = ON
• IN.CMD.AP	Present Man = OFF	Pres. APCH or CH = ON
• LAMP/CORT	Slowdown = OFF	Slowdown = ON
• PGM. AUT.	Follow Me = OFF	Follow Me = ON
• T. MOT.	PGM at distance = OFF	PGM at distance = ON
• T. MOT. PED	Alternated flashing signal with LED T. PAUSA	
• T. PAUSA	Alternated flashing signal with LED T. MOT. PED	

• EXTENDED MENU 1 ACCESS

To access the Extended Menu 1 functions, follow these instructions:

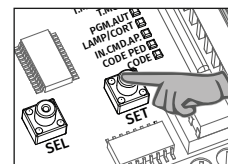

- 01** • Continuously press the **SET** button for 5 seconds.

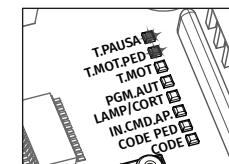

- 02** • The **T.MOT. PED** and **T.PAUSA LEDs** start to flash alternately.

i After entering the **Extended Menu 1**, you have 30 seconds to select any function of this menu (using the SEL and SET keys). After 30 seconds without pressing any button, the control board returns to the main menu.

04. PROGRAMMING

EXTENDED MENU 1

• CODE | STEP BY STEP / AUTOMATIC FUNCTIONING

Automatic Mode Functioning (LED CODE ON):

- The first impulse transmitter/pushbutton triggers the opening of the gate.
- The second impulse (after gate fully opens) triggers the closing of the gate.
- If you press the transmitter key during opening or closing maneuver, the gate inverts the direction of the operation until it reaches the limit switch.

Step by Step Mode Functioning (LED CODE ON):

For each order you send from a remote control / push button, the control board will have a behave like: open-stop-close-stop-open - (...). The control board is supplied by the manufacturer with the step by step active.

To change the operating mode, proceed as follows:

01 • Enter the Extended Menu 1 (see "EXTENDED MENU 1 ACCESS" on page 11B).

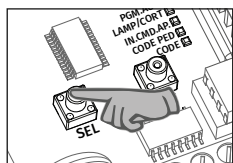

02 • Press the **SEL** key once, and the **CODE LED** begins to flash.

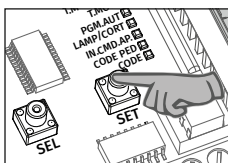

03 • Press the **SET** button once to change the operating mode.

04 • The **CODE LED** will light on / off permanently, indicating that the change of operation mode was successful.

• CODE PED. | ELECTRIC BRAKE

With this function active, when the automatism finishes a maneuver (reaching the limit switch), the control board briefly reverses the motor's power supply to stop it immediately (eg. gates with inclination).

The control board is supplied by the manufacturer with this function disabled.

Enable (LED ON) / Disable (LED OFF) function:

01 • Enter the Extended Menu 1 (see "EXTENDED MENU 1 ACCESS" on page 11B).

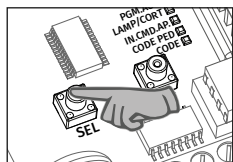

02 • Press **SEL** button the times necessary until the **CODE PED LED** starts to flash.

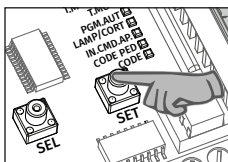

03 • Press the **SET** button once to change the operating mode.

04 • The **CODE PED LED** on means that the function is active and the **LED** off means that the function is disabled.

04. PROGRAMMING

EXTENDED MENU 1

• INB. CMD. AP | PRESENT MAN FUNCTIONING

When this function is active, the control board only opens / closes the automatism while the key of the transmitter / push button is pressed.

If it is released, the automatism stops immediately.

The control board is supplied by the manufacturer with this function disabled.

Enable (LED ON) / Disable (LED OFF) function:

01 • Enter the Extended Menu 1 (see "EXTENDED MENU 1 ACCESS" on page 11B).

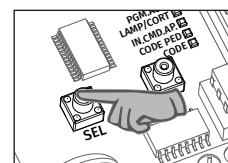

02 • Press **SEL** button the times necessary until the **INB CMD AP LED** starts to flash.

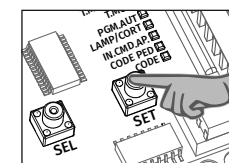

03 • Press once **SET** button to activate / deactivate the function.

04 • The **INB CMD AP LED** on means that the function is active and the **LED** off means that the function is disabled.

• LAMP/CORT | SLOWDOWN

This function enables / disables the existence of slowdown in opening and closing.

With this function disabled, it is not possible to set a slowdown during the motor's working time programation, in both manual and automatic programming.

When you activate this function, you must make a new working time program (manual or automatic), so that the changes become operational.

The control board is supplied by the manufacturer with the slowdown active.

Enable (LED ON) / Disable (LED OFF) function:

01 • Enter the Extended Menu 1 (see "EXTENDED MENU 1 ACCESS" on page 11B).

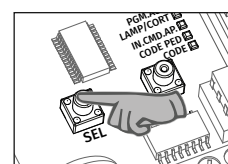

02 • Press **SEL** button the times necessary until the **LAMP/CORT LED** starts to flash.

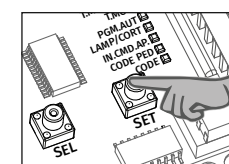

03 • Press once **SET** button to activate / deactivate the function.

04 • The **LAMP/CORT LED** will light on/off and the setup is complete.

04. PROGRAMMING

EXTENDED MENU 1

• PGM. AUT. | FOLLOW ME

With a programmed pause time, you can activate the "Follow Me" option. With this option enabled, whenever the photocells detect the passage of a user / object, the control board triggers the closing maneuver after 5 seconds.

The control board is supplied by the manufacturer with the function disabled.

Enable (LED ON) / Disable (LED OFF) function:

01 • Enter the Extended Menu 1 (see "EXTENDED MENU 1 ACCESS" on page 11B).

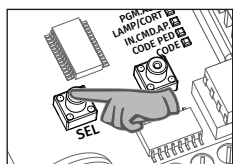

02 • Press **SEL** button the times necessary until the **PGM. AUT. LED** starts to flash.

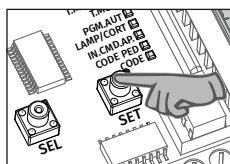

03 • Press once **SET** button to activate / deactivate the function.

04 • The **PGM. AUT. LED** on means that the function is active and the **LED** off means that the function is disabled.

• T. MOT | PROGRAMMING TRANSMITTERS AT DISTANCE

This function allows you to program new transmitters without access directly to the control board, by using another already programmed transmitter to open the memory. The control board is supplied by the manufacturer with the function disabled.

Enable (LED ON) / Disable (LED OFF) function:

01 • Enter the Extended Menu 1 (see "EXTENDED MENU 1 ACCESS" on page 11B).

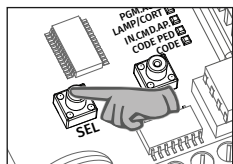

02 • Press **SEL** button the times necessary until the **T.MOT. LED** starts to flash.

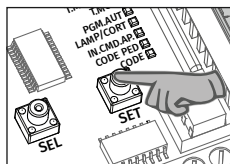

03 • Press once **SET** button to activate / deactivate the function.

04 • The **T.MOT. LED** on means that the function is active and the **LED** off means that the function is disabled.

Programming transmitter at distance:

01 • Press the button of an already programmed transmitter for 11seg, controlling with a clock, to open the control board's memory (when the memory opens, you hear a signal through the flashing light).

02 • Press the new transmitter key for 1 second, to program it.

NOTE: If a new key is not pressed, after 10 seconds, the control board closes the memory.

04. PROGRAMMING

EXTENDED MENU 2

The Extended Menu 2 allows you to program the motor's force/speed during the slowdown phase (idling). The control board has 6 different levels of force/speed, represented by the combination of lit LEDs, as indicated in the table below.

The control board is supplied by the manufacturer with the power set at level 3.

LEDS	Force Level					
	1	2	3	4	5	6
T.MOT						
PGM.AUTO						
L.CORT						
INB.CMD.AP						
CODE PED						
CODE						

Program the idle force/speed through the Extended Menu 2:

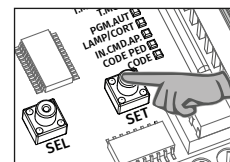

01 • Continuously press the **SET** button for 5 seconds to activate the Extended Menu 1.

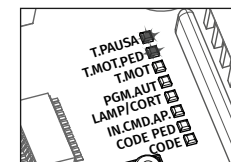

02 • The LEDs **T.MOT. PED** and **T.PAUSA** will flash alternately.

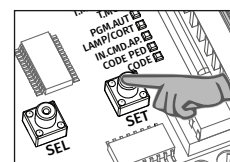

03 • Press again the **SET** key for 5 seconds.

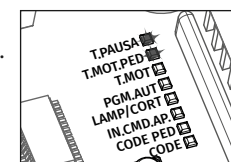

04 • The **T.MOT. PED** and **T.PAUSA LEDs** stop flashing alternately and start flashing simultaneously.

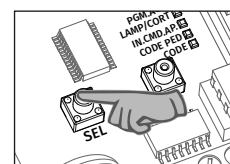

05 • Now press the **SEL** button repeatedly to select the desired level of force.

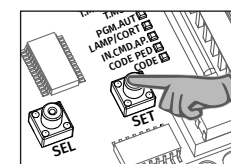

06 • Press the **SET** key once, to selected that option.

After entering the Extended Menu 2, you have 30 seconds to select any function of this menu (using the SEL and SET keys). After 30 seconds without pressing any button, the control board returns to the main menu.

04. PROGRAMMING

OTHER INFORMATION

• CONTROL BOARD'S RESET

If you need to restore the control unit to the factory settings, follow these steps:

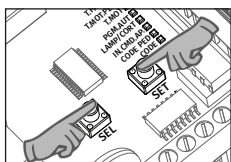

01 • Press the **SEL** and **SET** buttons simultaneously for 10 seconds.

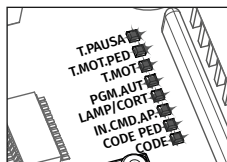

02 • All the LEDs will light up simultaneously and then off, completing the operation.

• LEDS MANAGEMENT

After 3 minutes of inactivity in the programming process, the control board automatically turns off all the LEDs in order to save energy.

A simple click on a button (SEL, SET or programmed transmitter) will turn on the LEDs of the programmed functions.

05. MAINTENANCE

PARAMETERS TO TAKE CARE



Before performing any maintenance, disconnect the control board from the electric current.

• VERIFICATIONS

Frequently check the installation for signs of lack of tightness or lubrication, imbalance during functioning and traces of wear or deterioration.

Also check the condition of the installation and external components (switch, keyboard or push buttons) and safety devices (photocells, safety edge) functioning. These are exposed to external agents that may shorten their lifetime.

If the device requires repair, bring/send it to our service center.

• ELIMINATION

At the end of its working life, the device must be removed from the place by a qualified installer who must take into account all precautions and safety measures during the procedure.

Never place the control board in household waste or uncontrolled landfills as it may contaminate the environment. The control board must be placed in appropriate recycling containers so that all components are separated according to their materials.

06. TROUBLESHOOTING

COMPONENTS TEST



All the tests should be performed by qualified personnel due to the high risk of accidents that may cause injury or death!

To detect if the malfunction is on the control board or on the motor is, sometimes, necessary to perform tests with connection directly to a 110V / 230V power supply. For this, it is necessary to interpose a capacitor on the connection in order to the automatism to work (check the type of capacitor to be used in the product manual). The diagram below, shows how to make that connection and how to merge the different components wires.

NOTES:

- > To perform the tests, there is no need to remove the automatism from the place it is installed, because in this way, it is possible to understand if the automatism can function properly connected directly to the current.
- > You should use a new capacitor during this test to ensure that the problem does not lie on it.

- 01 • Connect the power wires to the terminal, as shown below.
- 02 • Connect the automatism wires in the terminal, interposing a capacitor in the opening and closing wires.
- 03 • Once these connections are completed, connect to a 110V / 230V power outlet, depending on the motor / control board in test.

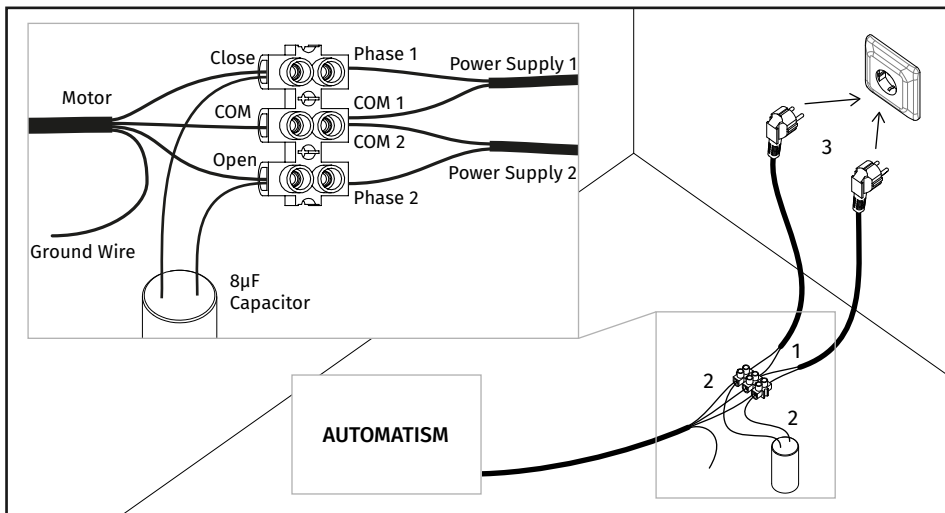

06. TROUBLESHOOTING

PHOTOCELLS AND TRANSMITTERS TEST

• PHOTOCELLS TEST

The control board is prepared for the connection of safety devices in accordance with section 5.1.1.6 of EN 12453.

In every maneuver is performed a test for the Security Device and the lock.

In case of a function/connection failure the motor doesn't start and every LED's remain in a intermittent mode, indicating the error. When the photocells operation is corrected, the control board returns to it's normal functioning. This action by the control board allows to recognize failures in accordance with is mentioned in category 2 of EN 954-1.

• TRANSMITTER'S TEST

In the position corresponding to each transmitter input in low voltage, the control board has a LED to identify the condition of it. The LED ON indicates that the input is closed, while the LED OFF indicates that the input is open.

06. TROUBLESHOOTING

INSTRUCTIONS FOR FINAL CONSUMERS

INSTRUCTIONS FOR SPECIALIZED INSTALLERS

Anomaly	Procedure	Behavior	Procedure II	Discovering the origin of the problem			
• Motor doesn't work	• Make sure you have 110/230V power supply connected to automation and if it is working properly.	• Still not working	• Consult a qualified MOTORLINE technician.	1 • Open control board and check if it has 110/230V power supply; 2 • Check the control board input fuses;	3 • Disconnect the motor from control board and test them by connecting directly to power supply in order to find out if they have problems (see page 16.A).	4 • If the motor works, the problem is on the control board. Pull it out and send it to our MOTORLINE technical services for diagnosis;	5 • If the motor doesn't work, remove them from installation site and send to our MOTORLINE technical services for diagnosis.
• Motor doesn't move but makes noise	• Unlock motor and move the gate by hand to check for mechanical problems on the movement.	• Encountered problems?	• Consult an experienced gate expert.	1 • Check all motion axis and associated motion systems related with the motor and the gate to find out what is the problem.			
		• The gate moves easily?	• Consult a qualified MOTORLINE technician.	1 • Check capacitors, testing operator with new capacitors;	2 • If capacitors are not the problem, disconnect motors from control board and test them by connecting directly to power supply in order to find out if they have problems (see page 16.A);	3 • If the motors work, the problem is from control board. Pull it out and send it to our technical services for diagnosis;	4 • If the motors doesn't work, remove them from installation site and send to our MOTORLINE technical services for diagnosis.
• Motor opens but doesn't close	• Unlock motor and move the gate by hand to closed position. Lock motor again and turn off power supply for 5 seconds. Reconnect it and send order to open gate using transmitter.	• Gate opened but didn't close again.	1 • Check if there is any obstacle in front of the photocells; 2 • Check if any of the control devices (key selector, push button, video intercom, etc.) of the gate are jammed and sending permanent signal to control unit; 3 • Consult a qualified MOTORLINE technician	All MOTORLINE control boards have LEDs that easily allow to conclude which devices are with anomalies. All safety devices LEDs (DS) in normal situations remain On. All "START" circuits LEDs in normal situations remain Off. If LEDs devices are not all On, there is some security systems malfunction (photocells, safety edges), etc. If "START" circuits LEDs are turn On, there is a control device sending permanent signal.		A) SECURITY SYSTEMS: 1 • Close with a shunt all safety systems on the control board (check manual of the control board in question). If the automated system starts working normally check for the problematic device. 2 • Remove one shunt at a time until you find the malfunction device. 3 • Replace it for a functional device and check if the motor works correctly with all the other devices. If you find another one defective, follow the same steps until you find all the problems.	B) SISTEMAS DE START: 1 • Disconnect all wires from START terminal input. 2 • If the LED turned Off, try reconnecting one device at a time until you find the defective device. NOTE: In case procedures described in sections A) and B) don't result, remove control board and send to our technical services for diagnosis.
• Gate doesn't make complete route	• Unlock motor and move gate by hand to check for mechanical problems on the gate.	• Encountered problems?	• Consult an experienced gate expert.	1 • Check all motion axis and associated motion systems related with the gate to find out what is the problem.			
		• The gate moves easily?	• Consult a qualified MOTORLINE technician.	1 • Check capacitors, testing with new capacitors; 2 • If capacitors are not the problem, disconnect motor from control board and test it by connecting directly to power supply in order to find out if it is broken; 3 • If the motor doesn't work, remove it from installation site	and send to our MOTORLINE technical services for diagnosis. 4 • If motor work well and move gate at full force during the entire course, the problem is from controller. Set force using trimmer on the board. Make a new working time programming, giving sufficient time for opening and closing with appropriate force (page 08.B or 9A).	5 • If this doesn't work, remove control unit and send it to MOTORLINE technical services.	NOTE: Setting force of the controller should be sufficient to make the gate open and close without stopping, but should stop and invert with a little effort from a person. In case of safety systems failure, the gate shall never cause physical damaged to obstacles (vehicles, people, etc.).