

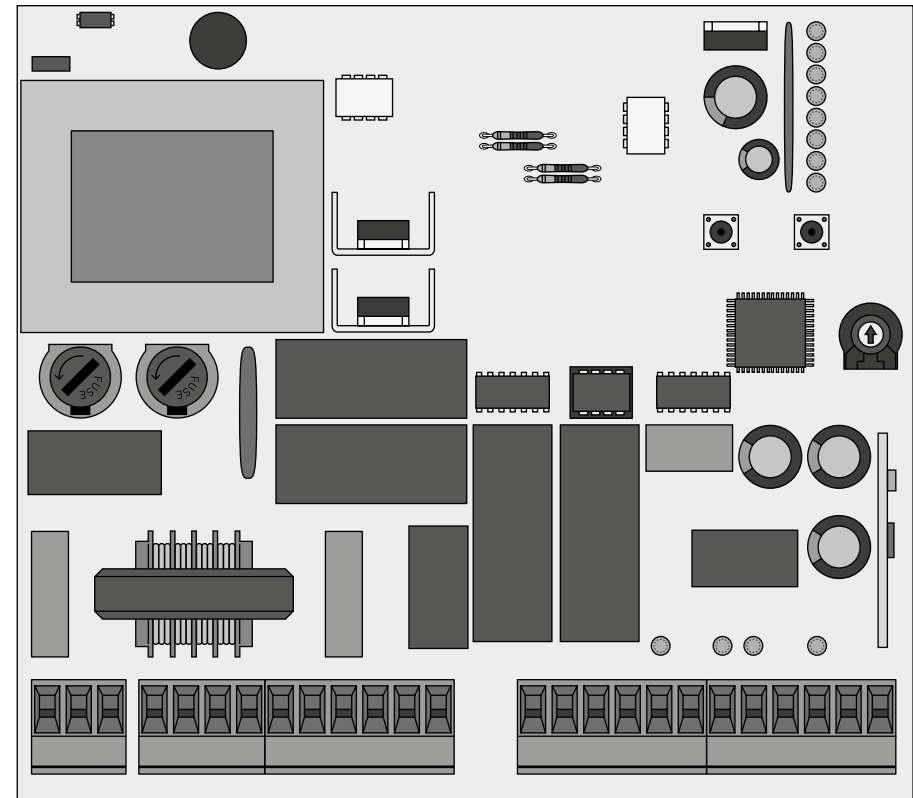

MC2

USER / INSTALLER MANUAL







00. CONTENT

INDEX

01. SAFETY INSTRUCTIONS	2B
02. THE CONTROL BOARD	
TECHNICAL SPECIFICATIONS	5A
PROGRAMMING PRE-RECOMENDATIONS	6A
03. CONFIGURATION	
MAIN MENU	7A
EXTENDED MENU 1	9B
EXTENDED MENU 2	11A
EXTENDED MENU 3	12B
RESET OF CONTROL BOARD	13A
04. COMPONENT TEST	
PHOTOCELLS TEST AND TRANSMITTERS	13A
CAPACITATOR SCHEME	13B
05. TROUBLESHOOTING	
INSTRUCTIONS FOR FINAL CONSUMERS	14
INSTRUCTIONS FOR SPECIALIZED INSTALLERS	14
06. CONNECTION SCHEME	
COMPONENT'S CONNECTION TO THE CONTROL BOARD	15

01. SAFETY INSTRUCTIONS

ATTENTION:

	This product is certified in accordance with European Community (EC) safety standards.
	This product complies with Directive 2011/65/EU of the European Parliament and of the Council, of 8 June 2011, on the restriction of the use of certain hazardous substances in electrical and electronic equipment.
	(Applicable in countries with recycling systems). This marking on the product or literature indicates that the product and electronic accessories (eg. Charger, USB cable, electronic material, controls, etc.) should not be disposed of as other household waste at the end of its useful life. To avoid possible harm to the environment or human health resulting from the uncontrolled disposal of waste, separate these items from other types of waste and recycle them responsibly to promote the sustainable reuse of material resources. Home users should contact the dealer where they purchased this product or the National Environment Agency for details on where and how they can take these items for environmentally safe recycling. Business users should contact their vendor and check the terms and conditions of the purchase agreement. This product and its electronic accessories should not be mixed with other commercial waste.
	
	This marking indicates that the product and electronic accessories (eg. charger, USB cable, electronic material, controls, etc.) are susceptible to electric shock by direct or indirect contact with electricity. Be cautious when handling the product and observe all safety procedures in this manual.

01. SAFETY INSTRUCTIONS

GENERAL WARNINGS

- This manual contains very important safety and usage information. very important. Read all instructions carefully before beginning the installation/usage procedures and keep this manual in a safe place that it can be consulted whenever necessary.
- This product is intended for use only as described in this manual. Any other enforcement or operation that is not mentioned is expressly prohibited, as it may damage the product and put people at risk causing serious injuries.
- This manual is intended firstly for specialized technicians, and does not invalidate the user's responsibility to read the "User Norms" section in order to ensure the correct functioning of the product.
- The installation and repair of this product may be done by qualified and specialized technicians, to assure every procedure are carried out in accordance with applicable rules and norms. Nonprofessional and inexperienced users are expressly prohibited of taking any action, unless explicitly requested by specialized technicians to do so.
- Installations must be frequently inspected for unbalance and the wear signals of the cables, springs, hinges, wheels, supports and other mechanical assembly parts.
- Do not use the product if it is necessary repair or adjustment is required.
- When performing maintenance, cleaning and replacement of parts, the product must be disconnected from power supply. Also including any operation that requires opening the product cover.
- The use, cleaning and maintenance of this product may be carried out by any persons aged eight years old and over and persons whose physical, sensorial or mental capacities are lower, or by persons without any knowledge of the product, provided that these are supervision and instructions given by persons with experienced in terms of usage of the product in a safe manner and

who understands the risks and dangers involved.

- Children shouldn't play with the product or opening devices to avoid the motorized door or gate from being triggered involuntarily.

WARNINGS FOR TECHNICIANS

- Before beginning the installation procedures, make sure that you have all the devices and materials necessary to complete the installation of the product.
- You should note your Protection Index (IP) and operating temperature to ensure that is suitable for the installation site.
- Provide the manual of the product to the user and let them know how to handle it in an emergency.
- If the automatism is installed on a gate with a pedestrian door, a door locking mechanism must be installed while the gate is in motion.
- Do not install the product "upside down" or supported by elements do not support its weight. If necessary, add brackets at strategic points to ensure the safety of the automatism.
- Do not install the product in explosive site.
- Safety devices must protect the possible crushing, cutting, transport and danger areas of the motorized door or gate.
- Verify that the elements to be automated (gates, door, windows, blinds, etc.) are in perfect function, aligned and level. Also verify if the necessary mechanical stops are in the appropriate places.
- The central must be installed on a safe place of any fluid (rain, moisture, etc.), dust and pests.
- You must route the various electrical cables through protective tubes, to protect them against mechanical exertions, essentially on the power supply cable. Please note that all the cables must enter the central from the bottom.
- If the automatism is to be installed at a height of more than 2,5m from the ground or other level of access, the minimum safety and

01. SAFETY INSTRUCTIONS

health requirements for the use of work equipment workers at the work of Directive 2009/104/CE of European Parliament and of the Council of 16 September 2009.

- Attach the permanent label for the manual release as close as possible to the release mechanism.
- Disconnect means, such as a switch or circuit breaker on the electrical panel, must be provided on the product's fixed power supply leads in accordance with the installation rules.
- If the product to be installed requires power supply of 230Vac or 110Vac, ensure that connection is to an electrical panel with ground connection.
- The product is only powered by low voltage safety with central (only at 24V motors)

WARNINGS FOR USERS

- Keep this manual in a safe place to be consulted whenever necessary.
- If the product has contact with fluids without being prepared, it must immediately disconnect from the power supply to avoid short circuits, and consult a specialized technician.
- Ensure that technician has provided you the product manual and informed you how to handle the product in an emergency.
- If the system requires any repair or modification, unlock the automatism, turn off the power and do not use it until all safety conditions have been met.
- In the event of tripping of circuits breakers or fuse failure, locate the malfunction and solve it before resetting the circuit breaker or replacing the fuse. If the malfunction is not repairable by consult this manual, contact a technician.
- Keep the operation area of the motorized gate free while the gate in in motion, and do not create strength to the gate movement.
- Do not perform any operation on mechanical elements or hinges if

the product is in motion.

RESPONSABILITY

- Supplier disclaims any liability if:
 - Product failure or deformation result from improper installation use or maintenance!
 - Safety norms are not followed in the installation, use and maintenance of the product.
 - Instructions in this manual are not followed.
 - Damaged is caused by unauthorized modifications
 - In these cases, the warranty is voided.

SYMBOLS LEGEND:



• Important safety notices



• Useful information



• Programming information



• Potentiometer information



• Connectors information



• Buttons information

02. THE CONTROL BOARD

TECHNICAL SPECIFICATIONS

The MC2 is a central electronic single phase with incorporated radio, for automation of swing gates.

• Power supply	110/230V AC 50-60Hz
• Lightbulb's output	110/230V AC 500W máx.
• Motor's output	110/230V AC 50/60 Hz 500W máx.
• Auxiliary accessories output	24V AC 15W máx.
• Safety and PB impulses	24V CC
• Working temperature	-10°C to +55°C
• Protection	IP56
• Incorporated Radio Receiver	433,92 Mhz
• OP Transmitters	12-18 bits or Rolling Code
• Maximum memory capacity	150 (CODE or CODE PED)
• Fuses	two 6.3A and 50mA fuses

• DIMENSIONS OF THE BOX AND CONTROL BOARD

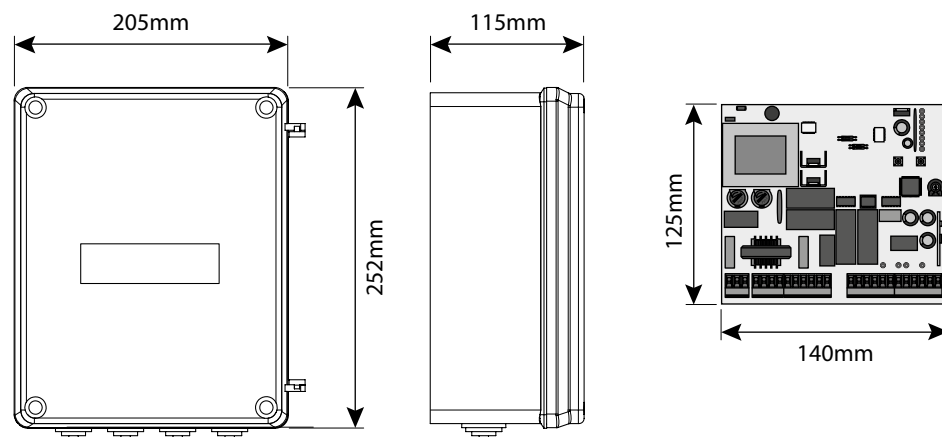

02. THE CONTROL BOARD

TECHNICAL SPECIFICATIONS

• CONNECTOR'S DESCRIPTION

CN1	<ul style="list-style-type: none"> 01 • Earth connection 02 • Earth connection 03 • Earth connection
CN2	<ul style="list-style-type: none"> 01 • AC 110/230V Line Input (PHASE) 02 • AC 110/230V Line Input (NEUTRAL) 03 • Lightbulb / Courtesy light's output (not blink) AC110/230V (NEUTRAL) 04 • Lightbulb / Courtesy light's output (not blink) AC110/230V (PHASE) 05 • Motor's Output 1 opening 06 • Motor's Output 1 common 07 • Motor's Output 1 closing 08 • Motor's Output 2 opening 09 • Motor's Output 2 common 10 • Motor's Output 2 closing
CN3	<ul style="list-style-type: none"> 01 • Output for power photocells 24V AC 02 • Output for power photocells (earth) 03 • Output for electric lock 12V DC 15W (+12V) 04 • Output for electric lock 12V DC 15W (earth) 05 • PUL input (button to order opening / closing) (NO) 06 • Earth common input 07 • PUL PED input (button to order pedestrian entry) (NO) 08 • DS1 Input safety device 1 (NC) 09 • Input common GND 10 • DS2 Input safety device 2 (NC) 11 • Antenna mass input 12 • Antenna hot pole input

02. THE CONTROL BOARD

PROGRAMMING PRE-RECOMENDATIONS

Before proceeding to the control board configuration, note the following points listed in the table below:

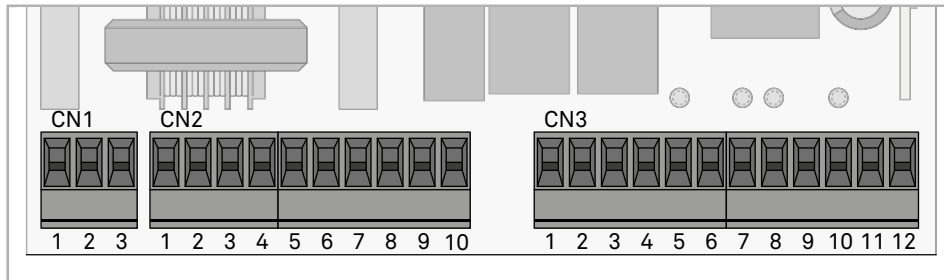

CN2

Lightbulb:

03 and 04 • This output allows connection of a lightbulb (see page 6B).

Capacitor:

05 and 07 • Connect the capacitor between the outputs 05 and 07.

08 and 10 • Connect the capacitor between the outputs 08 and 10.

CN3

Electric lock:

03 and 04 • This output allows connection of an electric lock (see page 11A)

Push button / selector:

05 • Allows connection the push-button / selector to full opening (NO).

06 • Allows connection the push-button / selector to full opening (NO).

Safety circuits:

08 • This circuit allows the connection of all types of safety devices such as photocells, safety edge, etc.

This device operates only in the gate closing maneuver and, when activated, it reverses the direction of the automatism.

10 • This circuit allows the connection of all types of safety devices such as photocells, safety edge, etc.

This device operates in the opening and closing maneuvers. In the closing maneuver, it reverses the direction of the automatism. In the opening maneuver, it stops the movement and, when it is released, the opening continues.

02. THE CONTROL BOARD

PROGRAMMING PRE-RECOMENDATIONS

• PROGRAMMING THE CONTROL BOARD - BUTTONS SEL/SET

SEL button: It makes the selection of the function to change. The selection is identified by the flashing of the LED corresponding to the selected function at that time.

Pressing the SEL button repeatedly will cycle through the various functions to be programmed. The selection remains active for 10 seconds, after these time the control board returns to original status (no active selection).

SET button: Makes programming the selected function through the SEL button.



The SET button may be substituted by a remote control from the latter is programmed.

• POWER AND SPEED OF MOTORS

The control board has a trimmer VR1 to adjust the force and speed of the motors controlled by the microprocessor. The adjustment can be effected between 50% and 100% the power.

At each start-up movement, the control board applies the maximum power during 2 seconds, even when it is made regulating force to a value than not the maximum.



When you adjust the trimmer VR1 has to remake course programming, as they could varied the times of maneuvering and deceleration.

• OPERATION OF LIGHTBULB

The operation of the output is conditioned by the movement of the motor and automatic closing. When the automatic closing is activated, the 110/230V output is activated even during pause time.

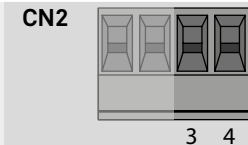

• OPERATION WITH TIMER

Instead of a opening / closing (PUL) push button, the control board can be operated with a TIMER. With a TIMER connected to the control board it is possible to program an exact time for the motor to perform both the opening and the closing, in automatic mode.

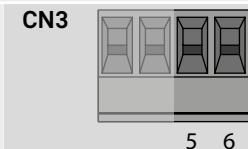

03. CONFIGURATION

MAIN MENU

This is the main menu of the control board MC2, which has access to the most important functions of its operation. The control board is supplied with the active main menu.

MAIN MENU		
LED	LED OFF	LED acceso
• AUT/P-P	Automatic	Step by step
• CODE	No code	Inserted code
• CODE PED.	No code	Inserted code
• INB. CMD. AP	Deactivated	Activated
• T. MOT.	Motor time 30 s.	Programmed time
• T. MOT. PED	Motor time pedestrian 10 s.	Programmed time
• T. PAUSA.	Without automatic closing	With automatic closing
• T. RIT. ANTE	No delay	Programmed time

• AUT/P-P | AUTOMATIC OPERATION / STEP BY STEP

Automatic operating mode (LED AUT / P-P OFF):

- The first impulse of the remote control / push-button activates the opening movement until the end of the motor's time.
- The second impulse of the remote control / push-button activates the closing movement until the end of the motor's time.

If an order is given before the end of the motor time, the control board will perform a inversion of movement in opening and closing.

Mode of operation step by step (LED AUT / P-P on):

- The first impulse of the remote control / push-button activates the opening movement until the end of the motor's time.
- The second impulse of the remote control / push-button activates the closing movement until the end of the motor's time.

If an order is given before the end of the motor time, the control board will stop the movement in opening and closing. A new order will return the operation, performed in the other direction to what it was before the stop.

The control unit is supplied by the manufacturer with the activated Automatic mode (LED AUT / P-P off).

Note: If the T. PAUSE is active (on) and the gate is stopped during the opening maneuver, the gate will stay stopped until the end of the pause time, and after that it will make the

03. CONFIGURATION

MAIN MENU

closing. If the gate is stopped during the closing maneuver, it will stop and will restart only when receive a new order.

Select operating mode:

01. Press the **SEL** button once, and the **AUT / P-P LED** will start to flash.

02. Press the **SET** button for 1 second.

03. The **AUT/PP LED ON** means that the "step by step" mode is selected. The **AUT/PP LED OFF** means that the "automatic" mode is selected.

• CODE | TRANSMITTER PROGRAMMING

The control board accepts only Dip-Switch or Rolling Code MOTORLINE transmitters, and has a maximum capacity of 150. When trying to program the 151° transmitter, all the programming LEDs will flash simultaneously to indicate that the memory is full.

To program new transmitters:

01. Press the **SEL** button as many times as necessary until the **CODE LED** flashes.

02. Press once the transmitter's button you want to program for 1 second.

03. The **LED CODE** lights up permanently, indicating the successful of the programming.

To delete all configured transmitters:

01. Press the **SEL** button once, and the **CODE LED** will begin to flash.

02. Press the **SET** button once. The **CODE LED** turns off and all transmitters have been deleted.

If the **CODE LED** starts to flash quickly, means that the control board did not accept the transmitters code, because of the following reasons:

- The transmitter is already programmed;
- The control board accepts only Rolling Code transmitters.

• CODE PED | PEDESTRIAN OPERATION

The control board allows to start only one motor in order to permit pedestrian passage. With this function, pressing the transmitter, will only open the door with the motor 1.

Programming the transmitters to pedestrian mode (CODE PED LED ON) / erase transmitter (CODE PED LED OFF):

01. Press the **SEL** button once until the **CODE PED LED** starts to flash.

02. Press the transmitter's button that you want to program during 1 second.

If you want delete transmitters, press the SET button for 1 second.

03. The **CODE PED LED ON** indicates that the transmitter is programmed and the **CODE PED LED OFF** indicates that the transmitters have been deleted.

03. CONFIGURATION

MAIN MENU

• INB. CMD. AP | TRANSMITTER INHIBITION DURING THE OPENING AND PAUSE TIME

With the function activated, the control board rejects all the transmitters signals during the opening maneuvers and automatic pause time. It's important that this function is activated during the magnetic loop installation, because the control board will ignore the crossings performed during the opening and the pause time.

The control board is supplied by the manufacturer with this function deactivated.

Activate (LED ON) / deactivate (LED OFF) function:

01. Press the **SEL** button the times necessary until the **INB CMD AP LED** starts to flash.
02. Press **SET** button for 1 second to enable / disable the function.
03. The **INB CMD LED AP ON** indicates that the function is active and the **LED OFF** indicates that the function is deactivated.

• T. MOT AND DECELERATION | MOTOR TIME PROGRAMMING AND DECELERATION

With this function, it's possible to trigger the slowdown, decreasing the gate's movement speed.

NOTE • To perform this programming is necessary that the motors have limit-switch or mechanical stop.

Instead of using the **SET** button of the control board, you can use a transmitter that is already programmed.

The control board is supplied by the manufacturer with a working time of motors established within 30 seconds, without deceleration.

Program working time of the motor with deceleration (Gate closed):

01. Press the **SEL** button the times necessary until the **LED T.MOT.** start to flash.
02. Press the **SET** button for 1 second, so that the Motor 1 start opening. **If the motor does not accept the opening, invert the cable connections 5 and 7, the CN2 connector (see page 4B).**
03. Press the **SET** button for 1 second, when the gate is at the desired point to start deceleration.
04. Press again **SET** button when you want to establish the opening limit-switch. At this time, **T. MOT. LED** will quickly flash and automatically the motor 2 will start the opening maneuver.
05. Press the **SET** button for 1 second, when the gate is at the desired point to start deceleration.
06. Press again **SET** button when you want to establish the opening limit-switch.
07. The **T. MOT.LED** will quickly flash indicating that programming for closing can be performed and automatically the motor 2 starts the closing maneuver. Repeat the process to program the closing.

03. CONFIGURATION

MAIN MENU

Program working time of the motor without deceleration (Gate closed):

01. Press the **SEL** button the times necessary until the **LED T.MOT.** start to flash.
02. Press the **SET** button for 1 second, so that the Motor 1 start opening. If the motor does not accept the opening, invert the cable connections 5 and 7, the CN2 connector (see page 4B).
03. Press twice the **SET** button when the gate is in the desired point to finish the opening course. At this time, **LED T. MOT.** will quickly flashing and automatically the motor 2 starts opening maneuver.
04. Press **SET** button two times when desires to establish the opening limit switch.
05. The **T. MOT.** will quickly flashing indicating that programming for closing can be performed and automatically the motor 2 starts the closing maneuver. Repeat the process to program the closing.

• T. MOT. PED | PROGRAMMING PEDESTRIAN WORKING TIME

To activate the pedestrian function, the control board allows to be just activated the operation of motor 1.

NOTE • To perform this programming is necessary that the motors have limit-switches or stoppers.

Instead of using the **SET** button on the control board, you can use a transmi that is already programmed.

The control board is supplied by the manufacturer with a pedestrian working time established in 10 seconds without deceleration.

Programming pedestrian working time with deceleration (gates closed):

01. Press **SEL** button as often as necessary until the **T. MOT. PED. LED** starts to flash.
02. Press the **SET** button for 1 second, so that the Motor 1 starts to open. **If the motor does not accept the opening, invert the cable connections 5 and 7, the CN2 connector (see page 4B).**
03. Press the **SET** button for 1 second, when the gate is the desired point to start deceleration.
04. Press again **SET** button when you want to establish the opening limit-switch. At this time, **T. MOT. PED. LED** will quickly flashing and automatically the motor 1 starts closing maneuver.
05. Press the **SET** button when the gate is at the desired point to start deceleration.
06. Press again **SET** button when you want to establish the closing limit-switch.
07. The **T. MOT. PED. LED** will light, signaling that the working time is programmed.

03. CONFIGURATION

MAIN MENU

Programming pedestrian working time without deceleration (gates closed):

01. Press **SEL** button as often as necessary until the **T. MOT. PED. LED** starts flashing.
02. Press the **SET** button for 1 second, so that the Motor 1 start opening. **If the motor does not accept the opening, invert the cable connections 5 and 7, the CN2 connector (see page 4B).**
03. Press twice the **SET** button, when you want to establish the opening limit switch. At this time, **LED T. MOT. LED** will quickly flashing and automatically the motor 1 starts closing maneuver.
04. Press twice the **SET** button when you want to establish the closing limit switch.
05. The **LED T. MOT. LED** will light, signaling that the working time is programmed.

• T. PAUSA | PROGRAMMING AUTOMATIC CLOSING

The control board permits an automatic closing after a set waiting time, maximum until 4 minutes.

The control board is supplied by the manufacturer with this function disabled.

NOTE • Instead of using the **SET** button on the control board, you can use a remote control that is already programmed.

Activate (LED ON)/deactivate (LED OFF) function:

1. Press **SEL** button as often as necessary until the **LED T. PAUSA** starts flashing.
2. Press the **SET** button for 1 second. From that moment, the waiting time before pressing **SET** will be equal to the time that the gate stays open.
3. Press the **SET** button for 1 second, when you reach the time that you want for the automatic closing.
4. The **LED T.PAUSA ON** indicates that the function is active and the LED off indicates that the function is disabled.

Delete programming:

01. Press the **SEL** button until the **LED T. PAUSA** will flashing.
02. Press the **SET** button twice in less than 2 seconds.
03. The **LED T. PAUSA** will off, signaling the success of the operation.

• T. RIT. ANTE | PROGRAMMING DOOR DELAY

This function can delay up to 30 seconds the start of the closing motor 1 in relation to the motor 2.

At the opening, the difference between the motor starting motor 2 to 1 is always 2 seconds.

The unit is supplied by the manufacturer with this function disabled.

03. CONFIGURATION

MAIN MENU

Programming:

01. Press the **SEL** button as often as necessary until the **LED T. RIT. ANTE** starts flashing.
02. Press the **SET** button for 1 second. From that moment, the waiting time before pressing **SET** will be equal to the time that the gate stays open.
03. Press the **SET** button for 1 second, when you reach the time that you want. Therefore, on closing, the delay time will be stipulated by the option while the opening is fixed in 2 seconds.
04. The **LED T. RIT. ANTE** will light permanently, indicating the memorization time delay between motor 1 and motor 2.

Delete programming:

01. Press the **SEL** button until the **LED T. RIT. ANTE** will flashing.
02. Press the **SET** button twice in less than 2 seconds.
03. The **LED T. RIT. ANTE** will off, signaling the success of the operation.

EXTENDED MENU 1

The control board is supplied by the manufacturer with an extended menu 1, which allows access to more functions of the control board.

To access the options of extended menu 1 follow these instructions:

01. Press continuously the **SET** button for 5 seconds and the **LED T.PAUSA** and **LED T. RIT. ANTE** will flash alternately.
02. You have 30 seconds to select functions from the extended menu 1 (using the **SEL** and **SET** button), and that after this time the control board returns to main menu.

EXTENDED MENU 1		
LED	LED OFF	LED ON
• AUT/P.P.	PGM distance OFF	PGM distance ON
• CODE	Photocells test ON	Photocells test OFF
• CODE PED.	Pressure maintenance OFF	Pressure maintenance ON
• INB. CMD. AP	Opening push OFF	Opening push ON
• T. MOT.	Closing push OFF	Closing push ON
• T. MOT. PED	Safety device 2	Blockade entrance
• T. PAUSA.	Alternative intermittence ON/OFF	
• T. RIT. ANTE	Alternative intermittence ON/OFF	

03. CONFIGURATION

EXTENDED MENU 1

• AUT/P-P | PROGRAMMING OF THE REMOTE CONTROL ON DISTANCE

The programming the transmitter at distance function, allows them to be added remote controls to the new control board without having to use the **SEL** button. The control board is supplied by the manufacturer with programming remote controls on distance deactivated.

Activate (LED ON) / deactivate (LED OFF) function:

01. Activate the extended menu 1.
02. Press **SEL** button once and the **AUT/P-P LED** will begin to flash.
03. Press for 1 second the **SET** button.
04. **AUT/P-P LED ON** indicates that the function is active and the **AUT/P-P LED OFF** indicates that the function is disabled.

Programming of transmitters on distance:

01. Press for 10 seconds the button of the remote control a previously memorized.
02. **LED CODE** will flash.
03. Press for 1 second one button of the remote control that you want to program.
04. The flash lamp will flash confirming the success of the operation.

• CODE | TEST OF PHOTOCELLS

The control board is supplied by the manufacturer with the photocells test deactivated.

Activate (LED ON)/deactivate (LED OFF) function:

01. Activate the extended menu 1
02. Press **SEL** button once and the **LED AUT/P-P** will begin to flash.
03. Press **SET** button for 1 second
04. The **LED CODE ON** indicates that the function is disabled and the **LED off** indicates that the function is activated.

NOTE • If you do not have the photocells installed, this test will not work.

• CODE PED | MOTORS PRESSURE

The pressure of the motors function, makes the control board to send closing orders for 2 seconds, once every two hours.

The control board is supplied by the manufacturer with the hydraulic motors pressure functionality OFF.

Activate (LED ON)/deactivate (LED OFF) function:

01. Activate the extended menu 1.
02. Press **SEL** button as often as necessary until the **CODE PED LED** starts to flash.

03. CONFIGURATION

EXTENDED MENU 1

03. Press **SET** button for 1 second.

04. The **CODE PED LED ON** indicates that the function is activated and the **CODE PED LED OFF** indicates that the function is disabled.

• INB. CMD. AP. | OPENING PUSH

The opening push function, facilitates the release of the lock when the opening is actuated, ensuring proper operation.

The control board is supplied by the manufacturer with the opening push disabled.

Activate (LED ON)/deactivate (LED OFF) function:

01. Activate the extended menu 1.
02. Press **SEL** button as often as necessary until the **INB. CMD. AP. LED** start to flash
03. Press **SET** button for 1 second
04. The **INB. CMD. AP LED ON** indicates that the function is activated and the **INB. CMD. AP LED OFF** indicates that the function is disabled.

• T. MOT. | CLOSING PUSH

With the closing push function, the control board case is programmed with deceleration, will add 1 second acting at full motor power, so that the gate can overcome the lock.

The control board is supplied by the manufacturer with the closing push disabled.

Activate (LED ON)/deactivate (LED OFF) function:

01. Activate the extended menu 1.
02. Press **SEL** button as often as necessary until the **LED T. MOT.** starts to flash.
03. Press **SET** button for 1 second
04. The **LED T.MOT. ON** indicates that the function is activated and the **LED T.MOT. OFF** indicates that the function is disabled.

• T. MOT. PED | SAFETY DEVICE 2 / BLOCKING

With the blocking function activated whenever the photocells (DS2) detected an obstacle, the gate movement will stop and will only triggered when you press the transmitter button. Before the gate resume movements, the lightbulb will flash during 5 seconds.

The control board is supplied by the manufacturer with blocking function disabled.

03. CONFIGURATION

EXTENDED MENU 1

Activate (LED ON) / deactivate (LED OFF) function:

01. Activate the extended menu 1.
02. Press **SEL** button as often as necessary until the **T. MOT. PED. LED** starts to flash.
03. Press **SET** button for 1 second.
04. The **T. MOT. PED. LED ON** indicates that the function is activated and the **T. MOT. PED. LED OFF** indicates that the function is disabled.

EXTENDED MENU 2

The control board is supplied by the manufacturer with an extended menu 2, which provides access to more functions to the control board.

To access the extended menu 2 options proceed as follows:

01. Enter the extended menu 1 (see page 06.B).
02. Press continuously the **SET** button for 5 seconds and the **T.PAUSA** and **T. RIT. ANTE LEDs** will flash simultaneously.
03. You have 30 seconds to select functions from the extended menu 2 (using the **SEL** and **SET** button), and after this time the control board returns to the main menu.

EXTENDED MENU 2		
LED	LED OFF	LED ON
• AUT/P.P.	Follow Me OFF	Follow Me ON
• CODE	Pre Lightbulb OFF	Pre Lightbulb ON
• CODE PED.	Lightbulb on pause OFF	Lightbulb on pause ON
• INB. CMD. AP	Soft start OFF	Soft start ON
• T. MOT.	Electronic lock PED OFF	Electronic lock PED ON
• T. MOT. PED	PUL=PUL PED=PED	PUL=AB PED=FECH
• T. PAUSA.	Intermittent simultaneously	
• T. RIT. ANTE	Intermittent simultaneously	

03. CONFIGURATION

EXTENDED MENU 2

• AUT/P-P | FOLLOW ME

With the pause time programmed, it is possible to trigger "Follow Me" option. With this option enabled, whenever the photocells detected the passage of a user/object, the control board triggers the closing maneuver after 5 seconds.

Activate (LED ON) / deactivate (LED OFF) function:

01. Enter the extended menu 2.
 02. Press once the **SET** button and the **AUT/P-P LED** starts flash.
 03. Press once **SET** button to enable / disable the function.
- The **AUT/PP LED ON** signals that the function is activated and the **AUT/PP LED OFF** signals that the function is disabled.

• CODE | PRE LIGHTBULB/LAMP.CORT

With the functioning in pre lightbulb, the output 03 and 04 (CN2) will always be activated 3 seconds before the automation start a movement. When disabled, the function returns lightbulb.

The control board is supplied by the manufacturer with the pre lightbulb disabled.

Activate (LED ON)/deactivate (LED OFF) function:

01. Enter the extended menu 2.
 02. Press **SEL** button as often as necessary until the **LED CODE** starts to flash.
 03. Press once **SET** button to enable / disable the function.
- The **LED CODE ON** signals that the function is activated and the **LED CODE OFF** signals that the function is disabled.

• CODE PED | OPERATION OF OUTPUT 110/230V FOR LIGHTBULB DURING THE PAUSE TIME

With this option enabled, whenever the motor is in pause time at output 110/230V for lightbulb will stay on.

The control board is supplied by the manufacturer with the lightbulb during pause time, disabled.

Activate (LED ON) / deactivate (LED OFF) function:

01. Enter the extended menu 2.
 02. Press **SEL** button as often as necessary until the **LED CODE PED** starts to flash.
 03. Press once **SET** button to enable / disable the function.
- The **LED CODE PED ON** indicates that the function is activated and the **LED OFF** signals that the function is disabled.

03. CONFIGURATION

EXTENDED MENU 2

• INB. CMD. AP. | SOFT START

With function "Soft Start" enabled, the beginning of each movement, the control board will control start the motor, increasing power gradually in the first 2 seconds of operation.

The control board is supplied by the manufacturer with the "Soft Start" disabled.

Activate (LED ON) / deactivate (LED OFF) function:

01. Enter the extended menu 2.
 02. Press **SEL** button as often as necessary until the **LED INB. CMD. AP.** starts to flash.
 03. Press once **SET** button to enable / disable the function.
- The **INB. CMD. AP. LED ON** indicates that the function is activated and the **INB. CMD. AP. LED OFF** signals that the function is disabled.

• T. MOT. | ELECTRONIC LOCK IN PEDESTRIAN FUNCTION

The electronic lock in pedestrian function is used when there is, for example, a swing doors assembled with electric lock to close the door 2. This makes it possible to obtain the opening of the gate by trigger a push-button connected in PUL, PED or to trigger the remote control.

The transmitter is supplied by the manufacturer with the electronic lock on the pedestrian function disabled.

Activate (LED ON)/deactivate (LED OFF) function:

01. Enter the extended menu 2.
 02. Press **SEL** button as often as necessary until the **T. MOT. LED** start to flash.
 03. Press once **SET** button to enable / disable the function.
- The **T. MOT. LED ON** indicates that the function is activated and the **T. MOT. LED OFF** signals that the function is disabled.

• T. MOT. PED | OPERATIONS THE INPUTS PUL AND PED

The control board permits that the PUL input work with a push button (NA) exclusively for opening and PED input work with a push button (NA) only for closing. The control board is supplied by the manufacturer with the operation of the PUL input for connection to a primary push-button (NA) cyclic and PED input for connecting a pedestrian pushbutton (NA) cyclic.

03. CONFIGURATION

EXTENDED MENU 2

PUL= opening, PED= closing (LED ON) / PUL=PUL and PED=PED (LED OFF):

01. Enter the extended menu 2.
 02. Press **SEL** button as often as necessary until the **LED T. MOT. PED** starts to flash.
 03. Press once **SET** button to change the function.
- The **T. MOT. PED LED ON** signals that the **PUL** is programmed for opening and **PED** for closing. The **T. MOT. PED LED OFF** indicates that the function **PUL** is programmed to function with a main cyclic push-button (NO) and the **PED** input to connect a pedestrian cyclic push-button (NO).

EXTENDED MENU 3

With the extended menu 3 can program the power / motor speed at which will be performed the deceleration.

To access the Extended menu 3 options proceed as follows:

01. Enter the extended menu 1 (see page 06.B).
02. Enter the extended menu 2 (see page 08.A).
03. Continuously press the **SET** button for 5 seconds and the **T.PAUSA** and **T. RIT. ANTE** LEDs will flash alternately for a few moments and flash simultaneously afterwards.
04. You have 30 seconds to select from the extended menu 3 functions (using the **SEL** and **SET** button), and after this time the control board returns to the main menu.

EXTENDED MENU 3	
LEVEL OF THE POWER	LEDS ON
1	AUT/P-P.
2	AUT/P-P. • CODE
3	AUT/P-P. • CODE • CODE PED
4	AUT/P-P. • CODE • CODE PED • INB. CMD. AP
5	AUT/P-P. • CODE • CODE PED • INB. CMD. AP • T. MOT.
6	AUT/P-P. • CODE • CODE PED • INB. CMD. AP • T. MOT. • T. MOT. PED

03. CONFIGURATION

EXTENDED MENU 3

Motor power programming during the deceleration:

It is possible to choose up to 6 different levels, relatively the force that the motor performs in deceleration. The levels are represented by combinations of the LED indicated in the table above.

Scroll through the LEDs with the **SEL** button to set the desired power, knowing that the **LED AUT / P-P. ON** corresponds to minimum power, while the **LEDs AUT / P-P., CODE, CODE PED, INB. CMD. AP, T. MOT., T. MOT. PED ON** correspond to maximum power.

The control board is supplied by the manufacturer with the power regulated at level 3 (**AUT / P-P., CODE, CODE PED ON**).

RESET TO CONTROL BOARD

If you need to restore control board to the factory setting, press the **SEL** and **SET** buttons simultaneously. All LEDs will light up temporarily, and when erased, the success of the operation is confirmed.

PHOTOCELLS AND CONTROLS TEST

• PHOTOCELLS TEST

The control board is prepared to a safety device connection in accordance with the section 5.1.1.6 of standard EN 12453. In every maneuver is performed a test for the Security Device and the Lock. In case of a function/connection failure the motor doesn't start and every LED's remain in a intermittent mode, indicating the error. When the photocells operation is corrected, the control board returns to its normal functioning. This action by the control board allows to recognize failures in accordance with is mentioned in category 2 of EN 954-1.

• TRANSMITTER'S TEST

In the position corresponding to each transmitter input in low voltage, the control board has a LED to identify the condition of it. The LED ON indicates that the input is closed, while the LED OFF indicates that the input is open.

04. COMPONENT TEST

CAPACITORS CONNECTION SCHEME

To detect if the malfunction is on the control board or on the motor is, sometimes, necessary to perform tests with connection directly to a 110/230V power supply. For this, it is necessary to interpose a capacitor on the connection in order to the automatism to work (check the type of capacitor to be used in the product manual). The diagram below, shows how to make that connection and how to merge the different components wires.

NOTES:

- > To perform the tests, there is no need to remove the automatism from the place it is installed, because in this way, it is possible to understand if the automatism can function properly connected directly to the current.
- > You should use a new capacitor during this test to ensure that the problem does not lie on it.

01 • Connect the power wires to the terminal, as shown below.

02 • Connect the automatism wires in the terminal, interposing a capacitor in the opening and closing wires.

03 • Once these connections are completed, connect to a 110/230V power outlet, depending on the motor/control board in test.

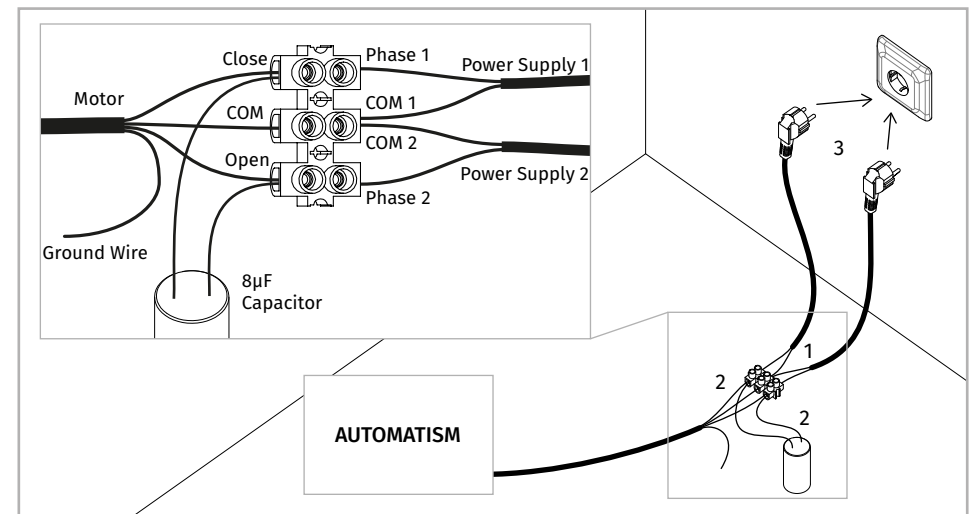

This test only applies to 110/230V motors. To test a 24V motor, just connect the motor cables to a 24V battery.

05. TROUBLESHOOTING

FINAL CONSUMERS INSTRUCTIONS

INSTRUCTIONS FOR SPECIALIZED INSTALLERS

Anomaly	Procedure	Behavior	Procedure II	Discovering the origin of the problem			
• Motor doesn't work	• Make sure you have 110/230V power supply connected to automation and if it is working properly.	• Still not working	• Consult a qualified MOTORLINE technician.	1 • Open control board and check if it has 110/230V power supply; 2 • Check the control board input fuses;	3 • Disconnect the motor from control board and test them by connecting directly to power supply in order to find out if they have problems (see page 10.B).	4 • If the motor works, the problem is on the control board. Pull it out and send it to our MOTORLINE technical services for diagnosis;	5 • If the motor doesn't work, remove them from installation site and send to our MOTORLINE technical services for diagnosis.
• Motor doesn't move but makes noise	• Unlock motor and move the gate by hand to check for mechanical problems on the movement.	• Encountered problems?	• Consult an experienced gate expert.	1 • Check all motion axis and associated motion systems related with the motor and the gate to find out what is the problem.			
		• The gate moves easily?	• Consult a qualified MOTORLINE technician.	1 • Check capacitors, testing operator with new capacitors;	2 • If capacitors are not the problem, disconnect motors from control board and test them by connecting directly to power supply in order to find out if they have problems (see page 10.B);	3 • If the motors work, the problem is from control board. Pull it out and send it to our technical services for diagnosis;	4 • If the motors doesn't work, remove them from installation site and send to our MOTORLINE technical services for diagnosis.
• Motor opens but doesn't close	• Unlock motor and move the gate by hand to closed position. Lock motor again and turn off power supply for 5 seconds. Reconnect it and send order to open gate using transmitter.	• Gate opened but didn't close again.	1 • Check if there is any obstacle in front of the photocells; 2 • Check if any of the control devices (key selector, push button, video intercom, etc.) of the gate are jammed and sending permanent signal to control unit; 3 • Consult a qualified MOTORLINE technician	All MOTORLINE control boards have LEDs that easily allow to conclude which devices are with anomalies. All safety devices LEDs (DS) in normal situations remain On. All "START" circuits LEDs in normal situations remain Off. If LEDs devices are not all On, there is some security systems malfunction (photocells, safety edges), etc. If "START" circuits LEDs are turn On, there is a control device sending permanent signal.	A) SECURITY SYSTEMS: 1 • Close with a shunt all safety systems on the control board (check manual of the control board in question). If the automated system starts working normally check for the problematic device. 2 • Remove one shunt at a time until you find the malfunction device. 3 • Replace it for a functional device and check if the motor works correctly with all the other devices. If you find another one defective, follow the same steps until you find all the problems.		B) SISTEMAS DE START: 1 • Disconnect all wires from START terminal input. 2 • If the LED turned Off, try reconnecting one device at a time until you find the defective device. NOTE: In case procedures described in sections A) and B) don't result, remove control board and send to our technical services for diagnosis.
• Gate doesn't make complete route	• Unlock motor and move gate by hand to check for mechanical problems on the gate.	• Encountered problems?	• Consult an experienced gate expert.	1 • Check all motion axis and associated motion systems related with the gate to find out what is the problem.			
		• The gate moves easily?	• Consult a qualified MOTORLINE technician.	1 • Check capacitors, testing with new capacitors; 2 • If capacitors are not the problem, disconnect motor from control board and test it by connecting directly to power supply in order to find out if it is broken; 3 • If the motor doesn't work, remove it from installation site	and send to our MOTORLINE technical services for diagnosis. 4 • If motor work well and move gate at full force during the entire course, the problem is from controller. Set force using trimmer on the board. Make a new working time programming, giving sufficient time for opening and closing with appropriate force (page 08.B).	5 • If this doesn't work, remove control unit and send it to MOTORLINE technical services.	NOTE: Setting force of the controller should be sufficient to make the gate open and close without stopping, but should stop and invert with a little effort from a person. In case of safety systems failure, the gate shall never cause physical damaged to obstacles (vehicles, people, etc.).

06. CONNECTION SCHEME

COMPONENT'S CONNECTION TO THE CONTROL BOARD

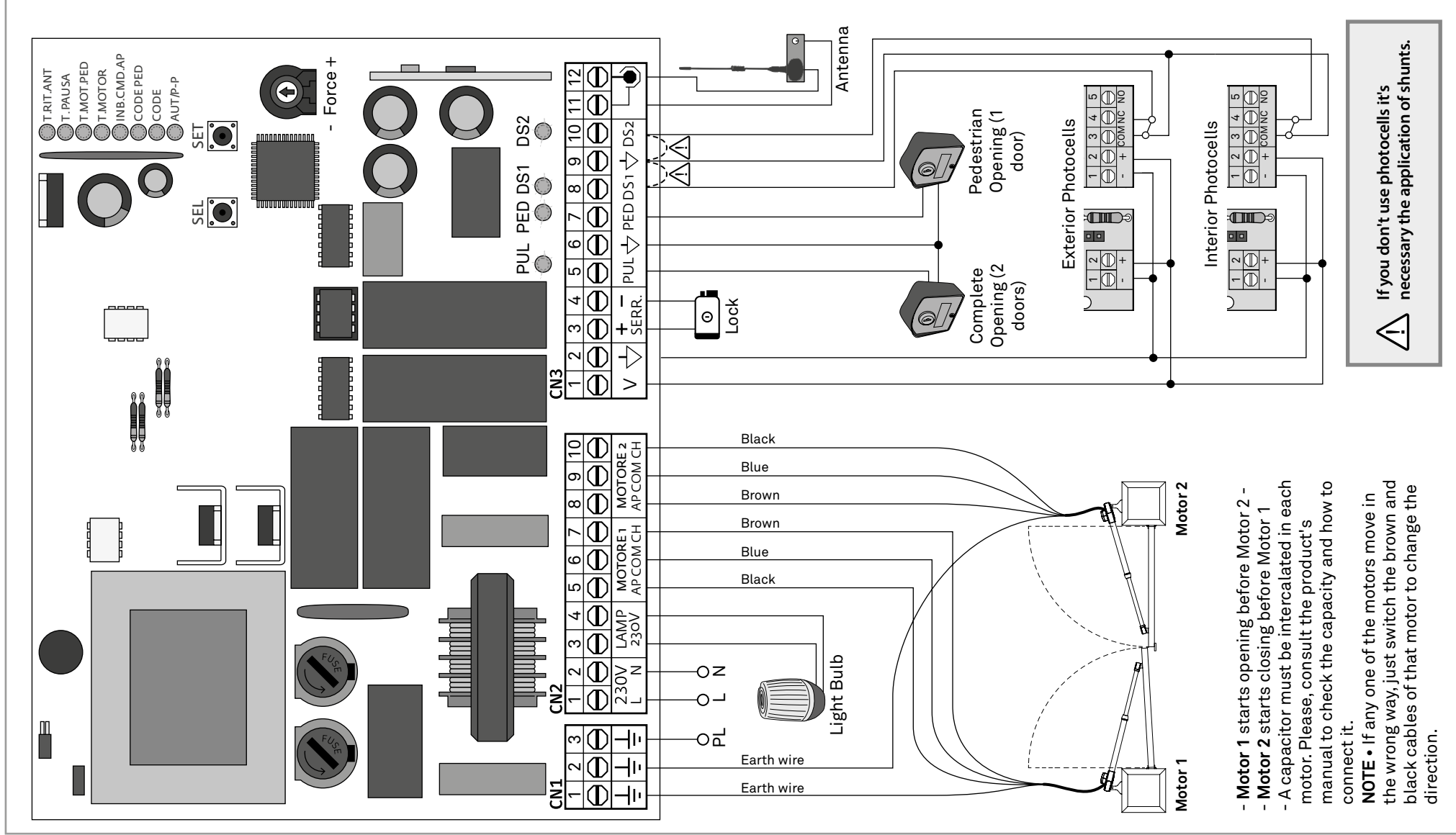

- Motor 1 starts opening before Motor 2 -
- Motor 2 starts closing before Motor 1
- A capacitor must be intercalated in each motor. Please, consult the product's manual to check the capacity and how to connect it.
- NOTE** • If any one of the motors move in the wrong way, just switch the brown and black cables of that motor to change the direction.

! If you don't use photocells it's necessary the application of shunts.